



WINE AND TAPAS BAR BOBO & CO DESTELBERGEN | BELGIUM



SQUBE on track

CEILING SURFACE

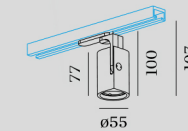

1.0 LED

LED | LED 6W | 220-240VAC | 50-60Hz
 COB 3-step | incl. PS | phase-cut dim
 aluminium powder coated
 incl. 1-phase track adapter

0.36kg IP20 0.3+D 36°

90° 355°

CODE

144164W_

144164B_

Light Colour Selection

	LUMEN	CRI	CODE
2700K	350	>80	2
3000K	380	>80	4
1800-3000K	350	>80	9

more 1-phase track accessories on
 page 586

OPTIONAL

dimmer

CODE

for switch 90019017

for din rail 90019018

more specs on page 576

for more support and planning of 1-phase track systems,
please check our FAQ section on weverducre.com

TRACK PROFILE 1M

recessed

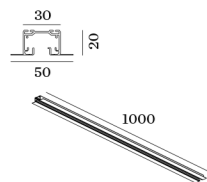

CODE

90014118

90014119

TRACK PROFILE 2M

recessed

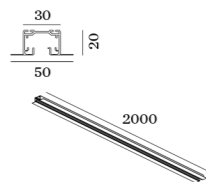

CODE

90014120

90014121

TRACK PROFILE 3M

recessed

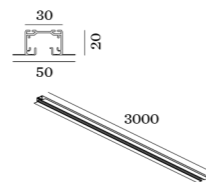

CODE

90014122

90014123

COVERPLATE END FEEDS

only use with recessed tracks



CODE

90014124

90014125

MIDDLE FEED

straight

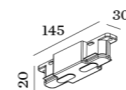

CODE

90014036

90014037

END CAP LEFT/RIGHT



CODE

90014028

90014029

TRACK ADAPTER

no space for driver
for suspension power cable
incl. strain relief



CODE

90014044

90014043

T-CONNECTOR

can be used as feed



CODE

90014010

90014011

TRACK PROFILE 1M

surface

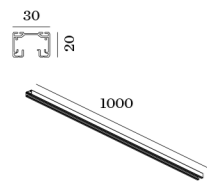

CODE

90014001

90014007

TRACK PROFILE 2M

surface

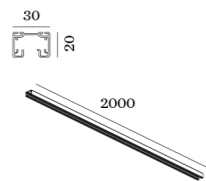

CODE

90014002

90014008

TRACK PROFILE 3M

surface

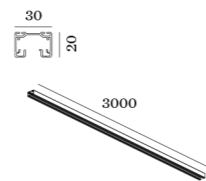

CODE

90014003

90014009

END FEED

left

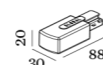

CODE

90014018

90014019

T-CONNECTOR

can be used as feed



CODE

90014012

90014013

T-CONNECTOR

can be used as feed



CODE

90014014

90014015

T-CONNECTOR

can be used as feed



CODE

90014016

90014017

X-CONNECTOR

can be used as feed



CODE

90014049

90014050

END FEED

right

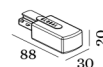

CODE

90014020

90014021

CONNECTOR

straight



CODE

90014022

90014023

L-CONNECTOR LEFT

can be used as feed

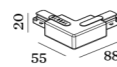

CODE

90014024

90014025

L-CONNECTOR RIGHT

can be used as feed

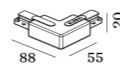

CODE

90014026

90014027

FLEXIBLE CORNER

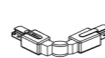

CODE

90014042

90014041

HEIGHT ADJ. SLEEVE



CODE

90014040

WIRE SUSPENSION



CODE

90014047

90014039

SUSPENSION CLAMP



CODE

90014038

SQUBE ON TRACK

20-04-2018

1.0 LED

LED 6W | 220-240VAC | 50-60Hz | COB3-step | incl. PS | phase-cut dim

CE \oplus \wedge 38° IP20 \square 960°C \perp 0,3m \oplus \updownarrow 90° \circlearrowleft 355°

white texture	144164W
black texture	144164B

LIGHT COLOUR

2700K >80CRI 350lm	2
3000K >80CRI 380lm	4
1800-3000K >80CRI 350lm	9

1-phase track accessories on second page

1.0 PAR16

PAR16 max. 35W | GU10 | 100-240VAC | 50-60Hz

CE \oplus IP20 \square 960°C \perp 0,9m \oplus \updownarrow 90° \circlearrowleft 355°

white texture	144120W0
black texture	144120B0

OPTIONAL

for PAR16 lamps see our catalogue
1-phase track accessories on second page

④

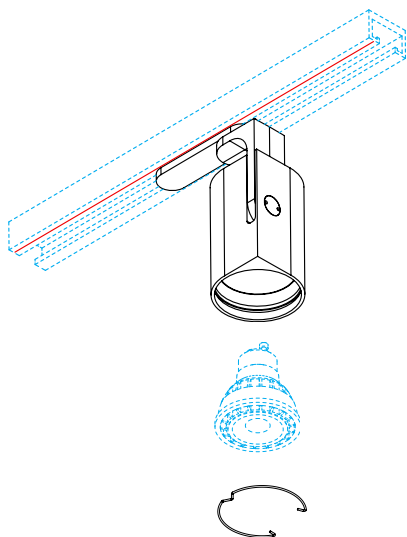

①

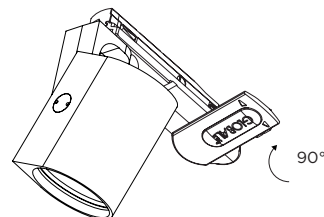

②



SAFETY ISSUE!
INSTALL THE FIXTURE
CORRECTLY ON THE TRACK
(see remark 2)

③

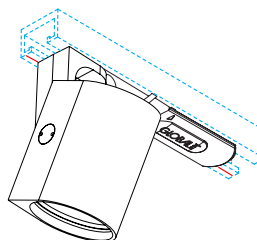

DIMENSIONS

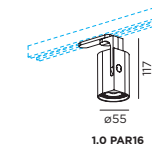
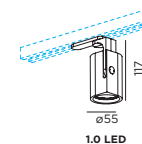

MOUNTING INSTRUCTION

- ① Turn the handle, which is mounted on the fixture, 90°.
- ② Push the fixture into the track. Make sure the \oplus icon on the inside of the adaptor is faced towards the track side with the small line craved in it. (marked red in the drawing)

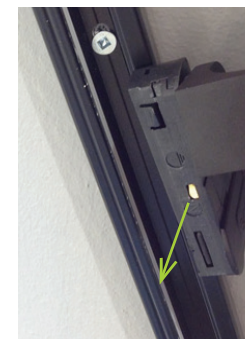

Make sure the handle is turned 90° when inserting the adapter into the track.

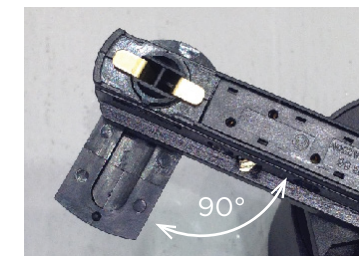

- ③ Turn the handle back into the original position.
- ④ For PAR16: mount the lamp into the fixture



WEVER & DUCRÉ
LIGHTING

www.weverducre.com

INSTALLATION
INSTRUCTIONS

PAGE 1/2

SQUBE ON TRACK

ACCESSORIES

TRACK PROFILE 1m | 1-phase

white
black

90014001
90014007



TRACK PROFILE 2m | 1-phase

white
black

90014002
90014008

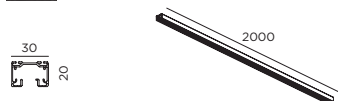

TRACK PROFILE 3m | 1-phase

white
black

90014003
90014009



END FEED left

white
black

90014018
90014019



END FEED right

white
black

90014020
90014021

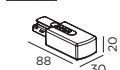

MIDDLE FEED

white
black

90014036
90014037

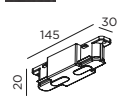

CONNECTOR straight

white
black

90014022
90014023



L-CONNECTOR left

white
black

90014024
90014025

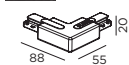

L-CONNECTOR right

white
black

90014026
90014027

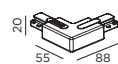

END CAP

white
black

90014028
90014029

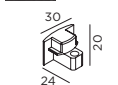

WEVER & DUCRÉ
LIGHTING

www.weverducre.com

INSTALLATION
INSTRUCTIONS

PAGE 2/2