



Fredericia

1 9 1 1

NO. 1 SOFA - 2-SEAT - BØRGE MOGENSEN



No. 1 Sofa - 2-seat - 2002

, D: 86 cm
H: 83 cm, Sh: 42 cm
Weight: 42 kg, Cbm: 0m³



DESCRIPTION

Mogensen designed the 2-seater sofa of the No.1 series in 1955. He united a sharply defined shape with a softer, more intimate character that can work well in any setting.

CONSTRUCTION

Hand upholstered corpus, wooden frame, interchangeable foam cushions. Legs in solid wood.

UPHOLSTERY

Fabric group: 1, 2, 3, 4, 5.

ACCESSORIES

Leather buttons for cushions with fabric.
Buttons in other colours than corpus and cushions.

GUARANTEE

Fredericia Furniture A/S offers a five-year guarantee against manufacturing defects in standard products (materials and construction). Wear and damage to covers, surface treatment, inappropriate use and the like are not covered by the warranty.



COLOUR WORLDS BY FREDERICIA

To help you navigate the vast swathes of fabrics, leathers and colours available, Fredericia has curated a refined materials toolbox to help make your choices as simple as possible.

Choosing the right upholstery to complement your interior can be quite a journey. The choice of fabric, leather and colour is crucial in the expression of each furniture piece and the role it plays in the interior – whether the style evokes classic restraint, contemporary boldness or daring creativity.

Fredericia's timeless mix of soft, natural shades rooted in Scandinavian nature stands outside of fast-moving trends with a long-lasting style that reflects the spirit of your time and place.

The fabrics produce a variety of tactile experiences that gravitate from heavy to light, from delicate to bold, and from calm to lively - awakening the senses in the ambience you want to create.

Dive into Fredericia's world of colours and create your own unique piece of furniture. 

Application Groups

A



Acme



Pato



Eve

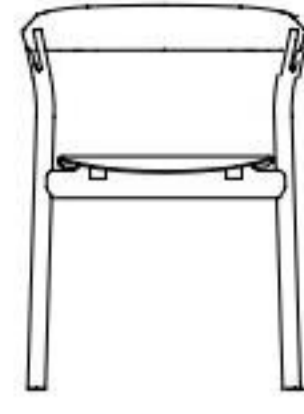

Yksi



Trinidad



Barbry



Spine

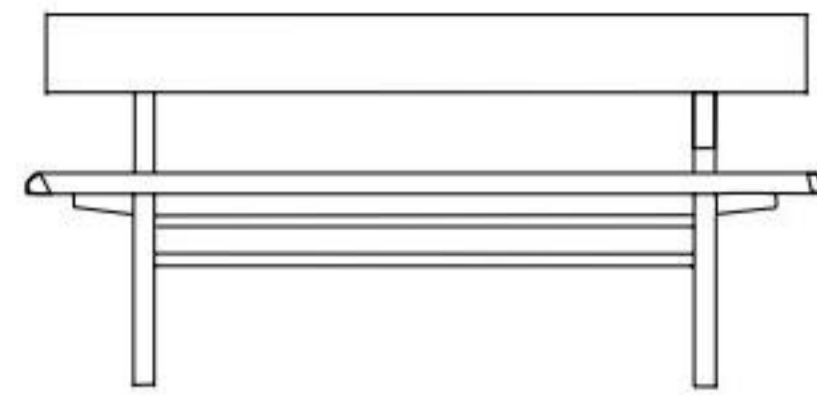

3171

B



Verve

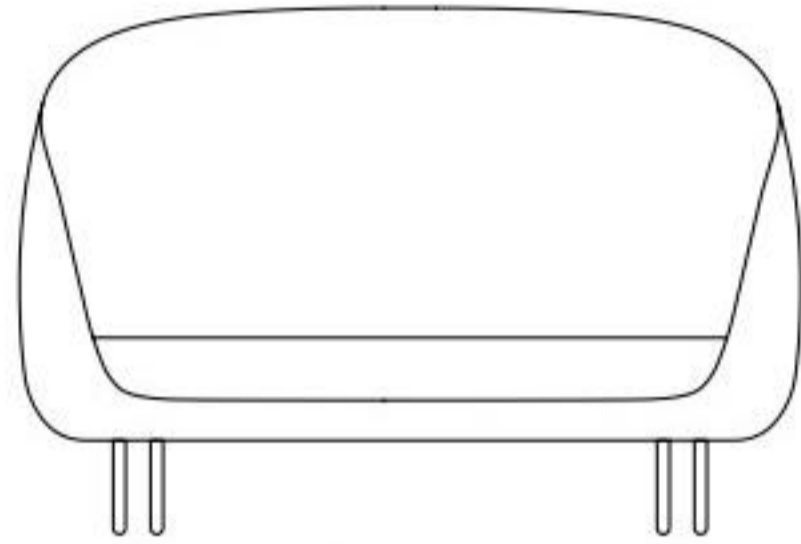

Haiku



Swoon

C

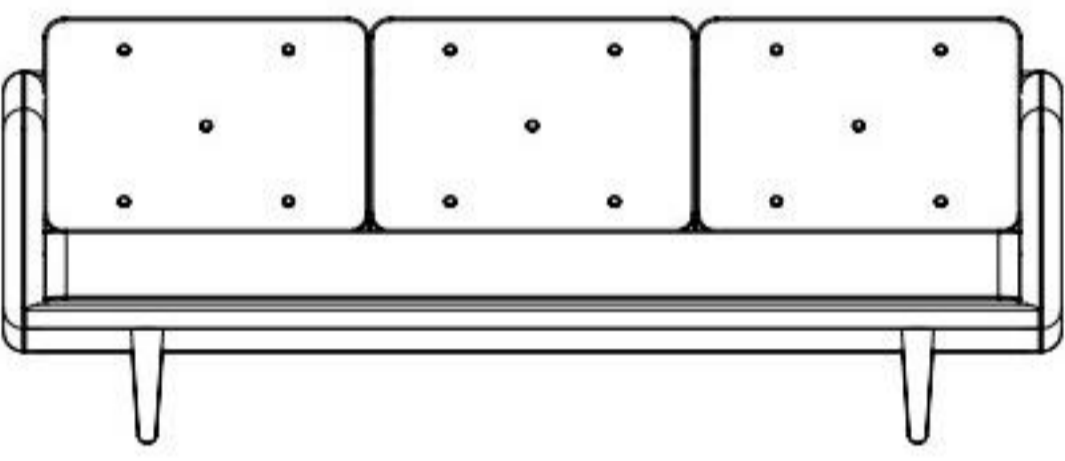

No 1

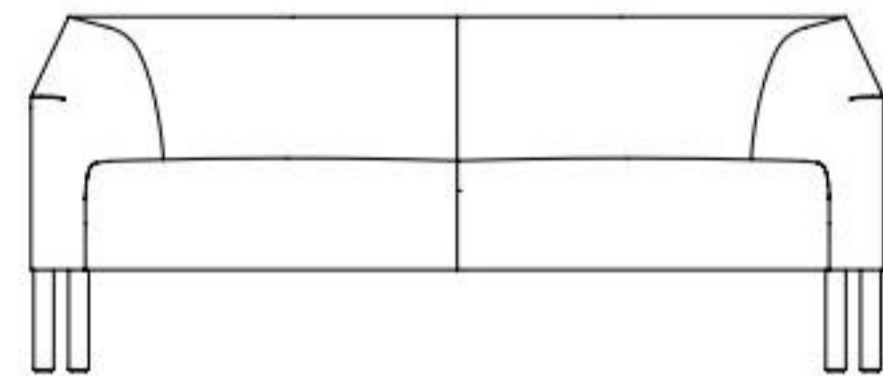

Kile

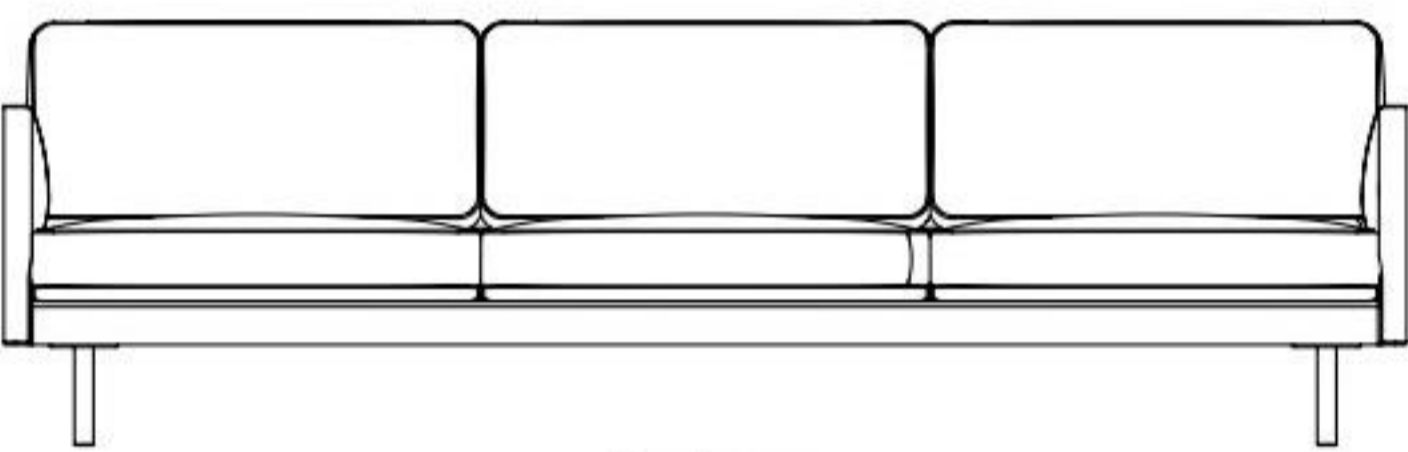

Calmo



A-Chair

D

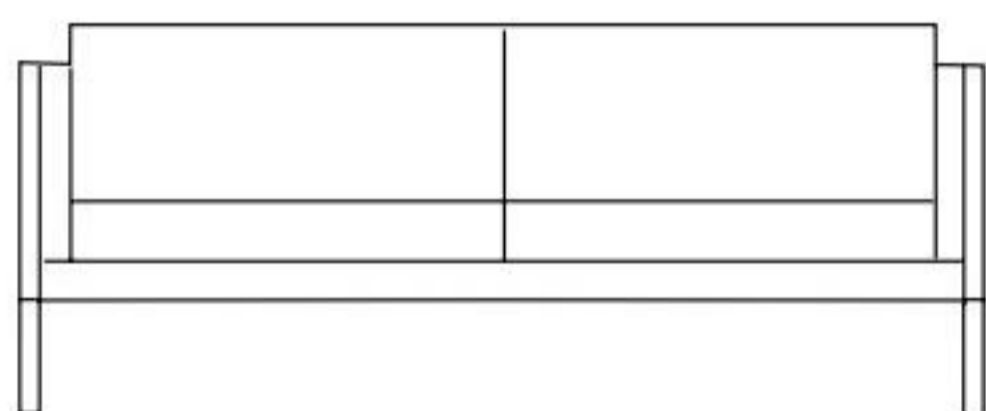

2300-series



Spine Lounge

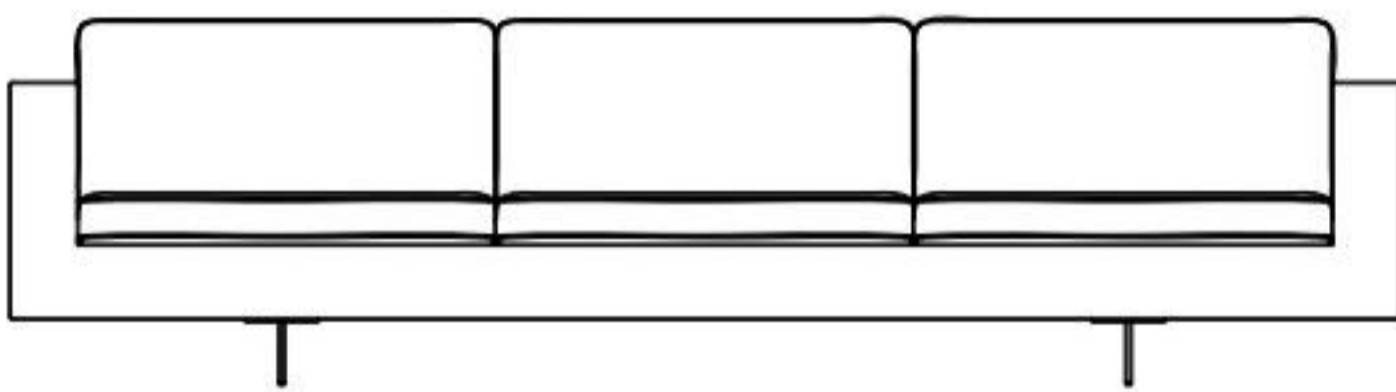

Risom 65 Sofa

E

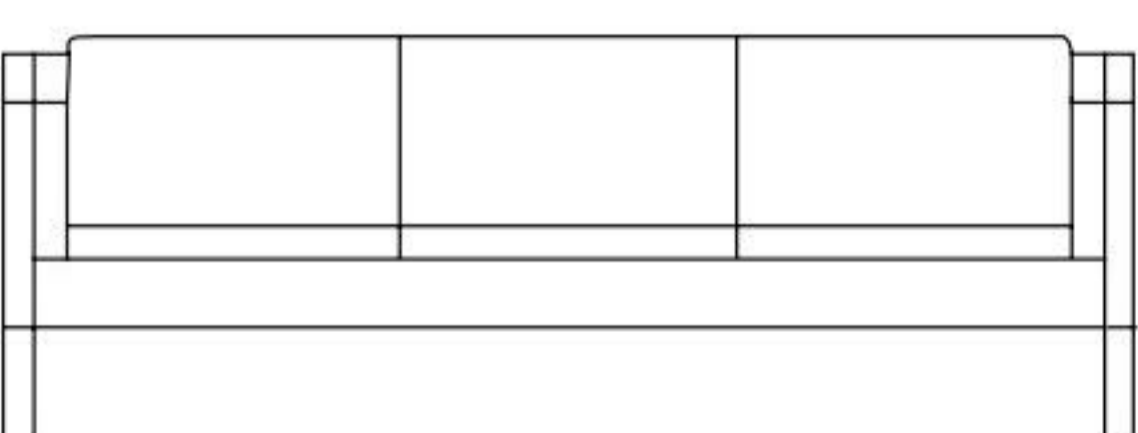

2212 / 2213

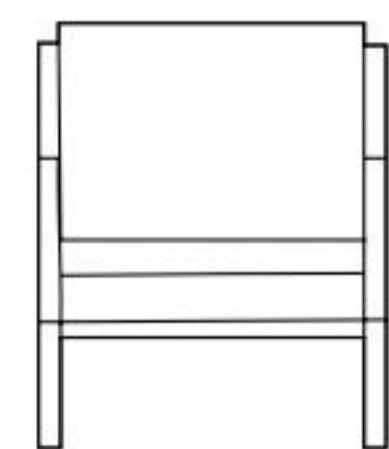

2207 / 2208 / 2209

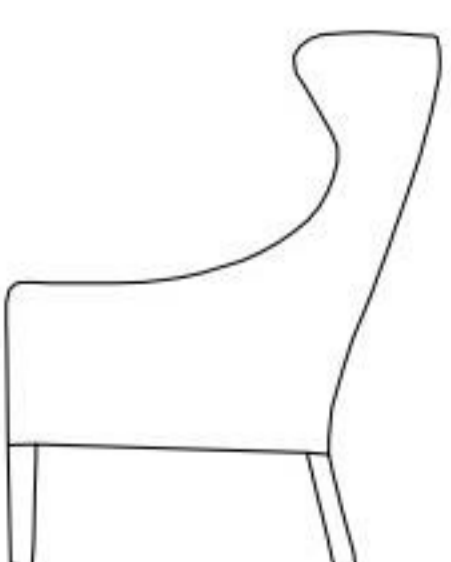

2204

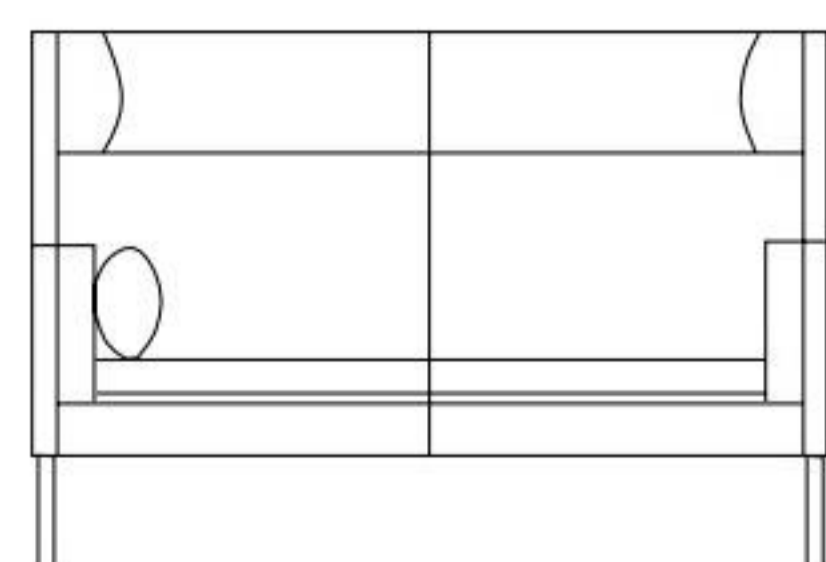

Coupé

Fabric Application

Fabric Group 1	A	B	C	D	E	Page
Fame	•	•				46
Maple	•	•	•	•		60
Mood	•	•	•	•		54
Remix	•					47
Rime	•	•	•			48
Ruskin	•	•	•	•	•	61
Fabric Group 2	A	B	C	D	E	
Aguila	•	•	•	•		60
Canvas	•			•		46
Carlotto	•	•	•	•		66
Craggan	•	•	•	•		52
Fiord	•	•	•	•		47
Grid	•	•	•	•		74
Hallingdal	•	•	•	•	•	54
Harald	•	•		•	•	71
Merit	•	•	•			75
Re-wool	•	•	•	•		48
Savanna	•	•	•	•		62
Steelcut Trio	•	•	•	•		56
Sunniva	•	•	•	•	•	62
Tonus	•	•	•			56
Fabric Group 3	A	B	C	D	E	
Comfort+	•	•	•	•		74
Divina	•	•	•	•	•	52
Divina Melange	•	•	•	•	•	53
Sinequanon	•	•	•	•	•	63
Twill weave	•	•	•	•	•	57
Vidar	•	•	•	•	•	57
Fabric Group 4	A	B	C	D	E	
Cobblestone	•	•	•	•		66
Grand Mohair	•	•				70
Tosca	•	•	•	•		63
Fabric Group 5	A	B	C	D	E	
Byram	•	•	•	•		70
Fuse	•		•	•	•	53
Noise	•	•	•	•	•	55
Pulsar	•		•	•	•	67
Pilot	•	•	•	•	•	67
Reflex	•		•	•	•	55
Sonar	•	•	•	•	•	61

CANVAS

Fabric Group 2



About	Flat wool textile with subtle striped texture. Large scale of colour blends.
Application	A
Composition	90% wool, 10% polyamide
Martindale	100 . 000
Environment	EU Ecolabel
Flame resistance	AS/NZS 1530.3, BS 5852 part 1, EN 1021-1/2, IMO FTP Code 2010 Part 8, NF D 60 013, NFPA 260, SN 198 898 5.3 with treatment, UNI 9175 1IM, US Cal. Bull. 117-2013, ÖNORM B1/ Q1, BS 5852 ignition source 3, BS 5852 Crib 5
Pilling	4
Lightfastness	6
More info	kvadrat.dk
Total no of colours	46



FAME

Fabric Group 1



About	Classic flat woven wool fabric in monochrome colours Suitable for flat upholstery.
Application	A B
Composition	95% wool, 5% polyamide
Martindale	100 . 000
Environment	EU Ecolabel
Flame resistance	BS EN 1021-1 Cigarette, BS EN 1021-2 Match, BS 5852 Crib 5, CA TB 117-2013, Class Uno UNI 9175 Class 1 I EMME, AM 18 - NF D 60-013, BS 5852 Part 1 0,1 Cigarette & match, ÖNORM B 3825-B1-3800-Q1 UK, IMO MSC 307(88) Annex 1 part 8, MED Certificate IMO, BS 476 Part 7, class 1
Pilling	4
Lightfastness	5-7
More info	gabriel.dk
Total no of colours	60



FIORD

Fabric Group 2



About	A soft, nubby surface and subtle colour blends wool fabric. Suitable for all upholstery.
Application	A B C D
Composition	92% wool, 8% polyamide
Martindale	60.000
Environment	EU Ecolabel
Flame resistance	BS 5852 Crib 5 with treatment, BS 5852 part 1, DIN 4102 B2, EN 1021-1/2, IMO FTP Code 2010 Part 8, NF D 60 013 UNI 9175 1IM, US Cal. Bull. 117-2013, AS/NZS 3837, class 2 SN 198 898 5.3 with treatment
Pilling	4-5
Lightfastness	6
More info	kvadrat.dk
Total no of colours	27



271
Clay



391
Dark brown

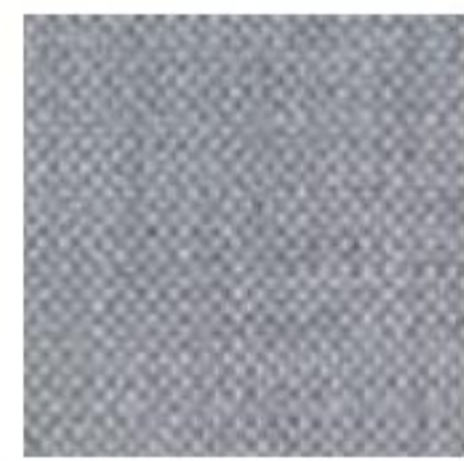

151
Cold grey



191
Charcoal



581
Deep red



961
Olive



751
Dusty blue

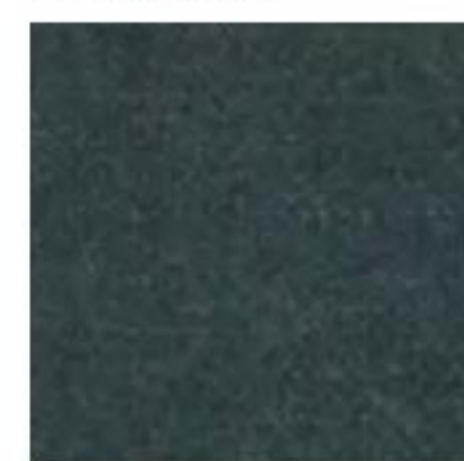

991
Ancient green

REMIX

Fabric Group 1



About	Flat wool textile with a large scale of colour blends.
Application	A
Composition	90% wool, 10% polyamide
Martindale	100.000
Environment	EU Ecolabel
Flame resistance	AS/NZS 1530.3, AS/NZS 3837, class 2, BS 5852 part 1, EN 1021-1/2, IMO FTP Code 2010 Part 8, NF D 60 013, NFPA 260, UNI 9175 1IM, US Cal. Bull. 117-2013, ÖNORM B1/ Q1, BS 5852 Crib 5
Pilling	5
Lightfastness	5
More info	kvadrat.dk
Total no of colours	49



252
Camel

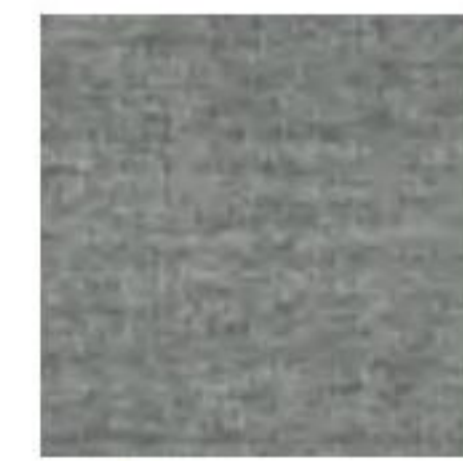

133
Clay



393
Dark brown



143
Cold grey

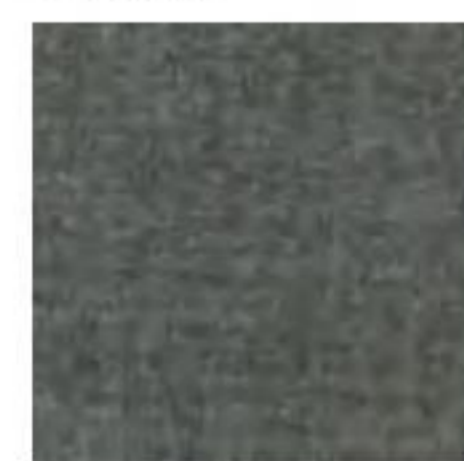

163
Charcoal



373
Deep red



433
Cognac



733
Dusty blue

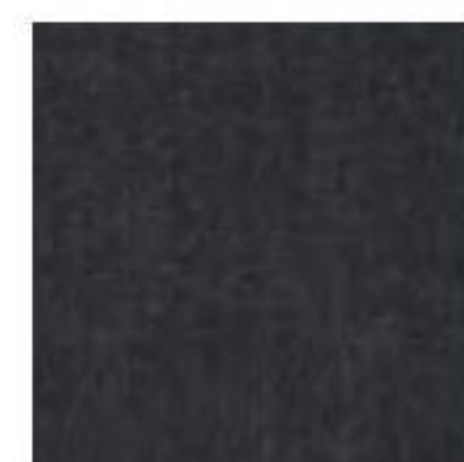

183
Navy blue

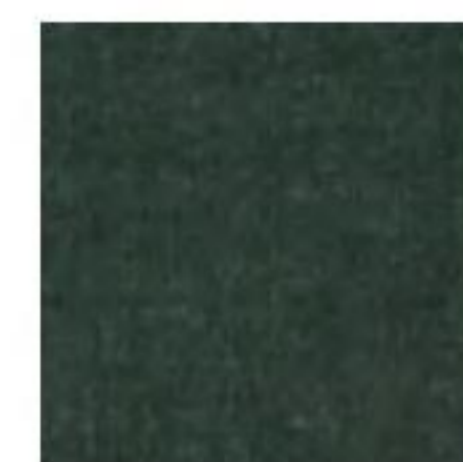

973
Ancient green

RIME

Fabric Group 1

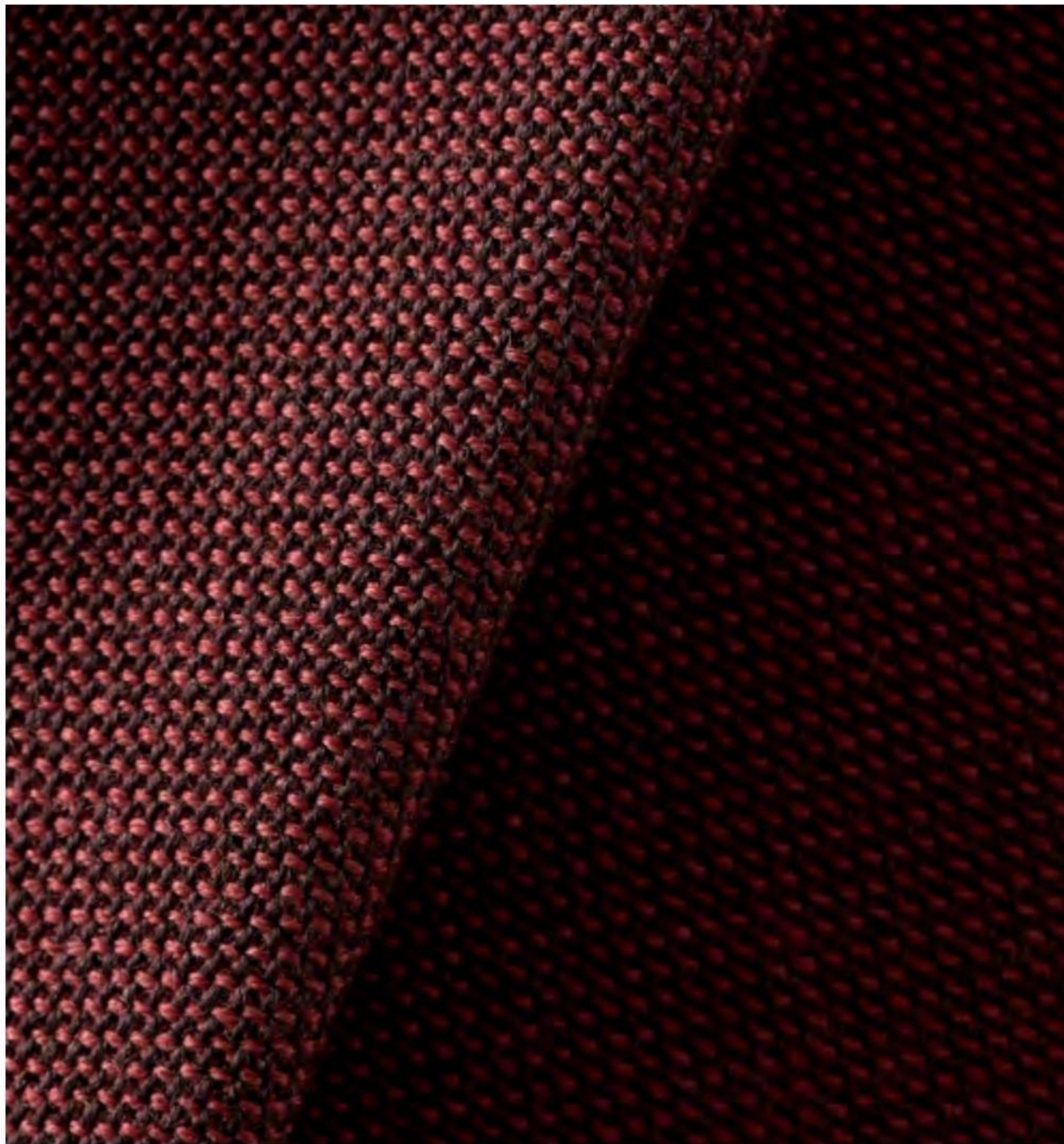

About	Classic wool two-tone textile with a beautiful melange effect.
Application	A B C D
Composition	90% wool, 10% polyamide
Martindale	100.000
Environment	EU Ecolabel
Flame resistance	AS/NZS 3837, class 2, BS 5852 part 1, DIN 4102 B2, EN 1021-1/2, IMO FTP Code 2010 Part 8, NF D 60 013, SN 198 898 5.3 with treatment, UNI 9175 1IM, US Cal. Bull. 117-2013, ÖNORM B2/Q1, BS 5852 Crib 5 with treatment, BS 5852 ignition source 3
Pilling	4
Lightfastness	5-6
More info	kvadrat.dk
Total no of colours	27



RE-WOOL

Fabric Group 2

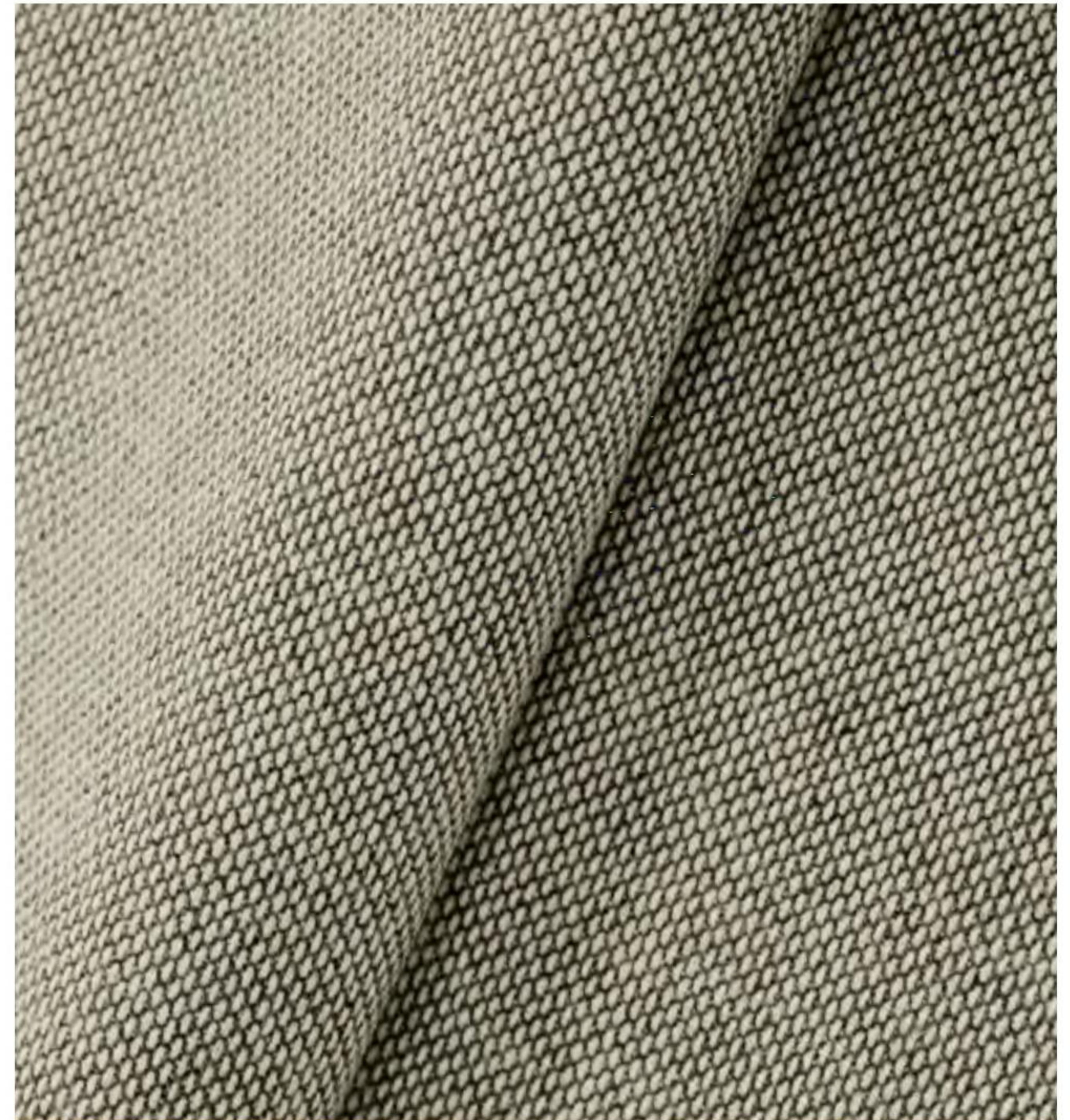

About	Upholstery textile with a subtle yet visible woven structure and soft colourways enriched by sparks. Produced using 45% recycled wool from Kvadrat's English mills.
Application	A B C D
Composition	45% wool, 45% recycled wool, 10% polyamide
Martindale	50.000
Environment	EU Ecolabel
Flame resistance	AS/NZS 1530.3, BS 5852 Crib 5 with treatment, BS 5852 ignition source 3, BS 5852 part 1, EN 1021-1/2, IMO FTP Code 2010 Part 8, NF D 60 013, UNI 9175 1IM, US Cal. Bull. 117-2013, ÖNORM B1/ Q1
Pilling	4
Lightfastness	7
More info	kvadrat.dk
Total no of colours	21



CRAGGAN

Fabric Group 2

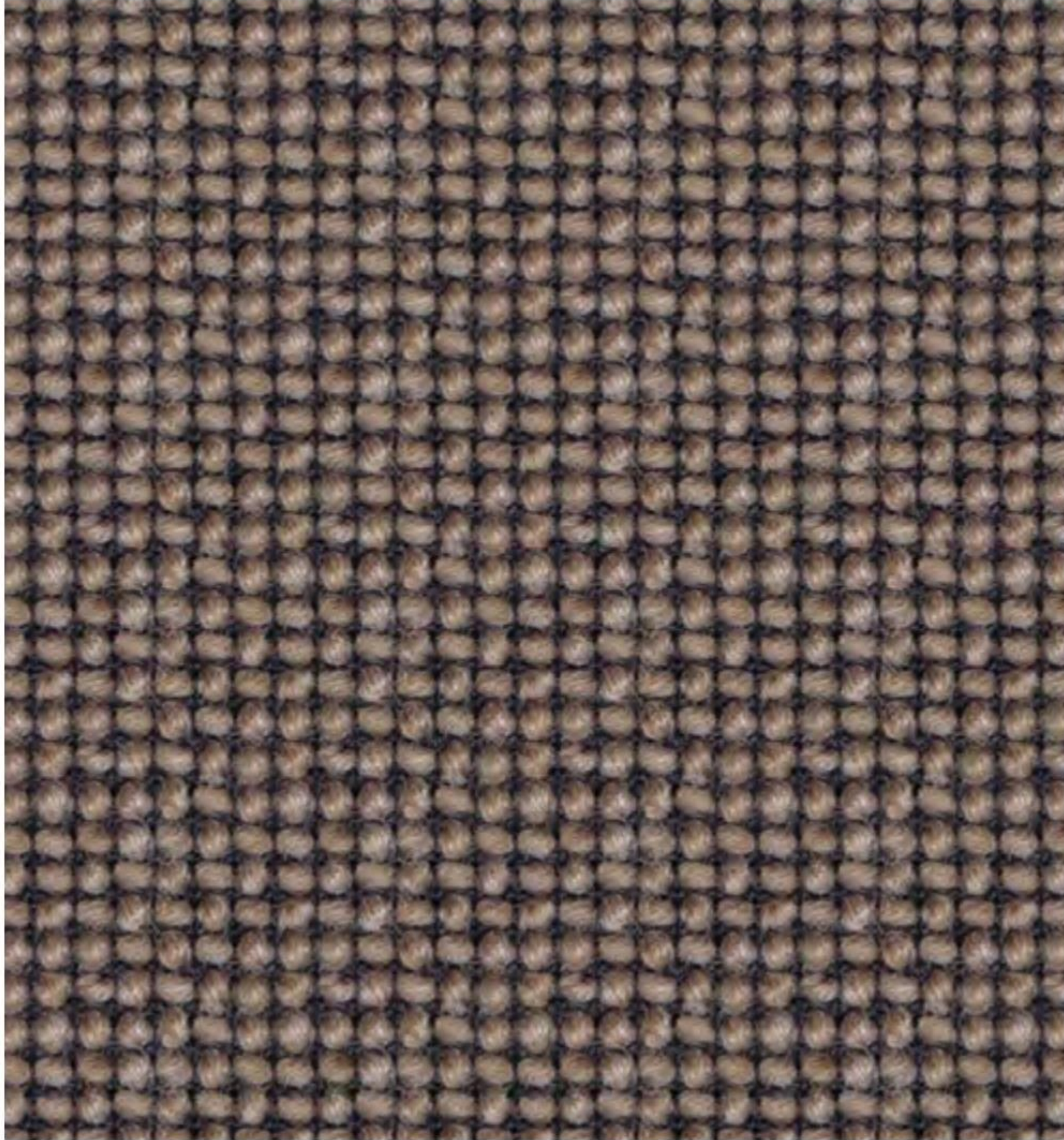

About	Voluminous wool textile with a remarkable yet harmonious texture. Two-tone woven with subtle contrasts.
Application	A B C D
Composition	100% wool
Martindale	50.000
Environment	Sustainable resource
Flame resistance	EN 1021 - 1 Cigarette, EN 1021 - 2 Match, BS 5852 Ignition Source 5
Pilling	4
Lightfastness	5
More info	camirafabrics.com
Total no of colours	10



02
Camel

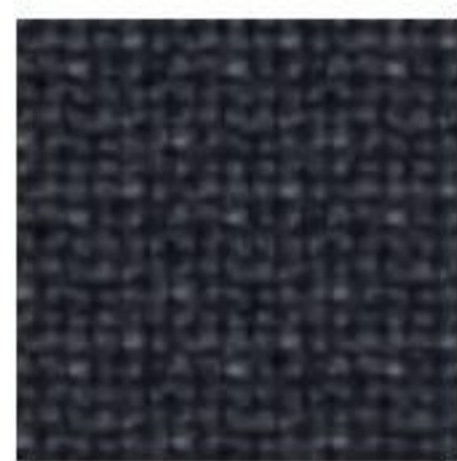

09
Charcoal



10
Cold grey

DIVINA 3

Fabric Group 3



About	Classic wool felt used for furniture as well as clothing. Divina 3 (monochrome) are suitable for all upholstery. Domestic to moderate public use.
Application	A B C D E
Composition	100% wool
Martindale	45.000
Environment	EU Ecolabel
Flame resistance	AS/NZS 1530.3, BS 5852 Crib 5, BS 5852 part 1, BS 5867 part 2 type B, EN 1021-1/2, EN 13501, C-s1, d0, glued, IMO FTP Code 2010 Part 8, NF D 60 013, NFPA 260, SN 198 898 5.3 with treatment, UNI 9175 1IM, US Cal. Bull. 117-2013, ÖNORM B1/ Q1, BS 5852 ignition source 3
Pilling	3
Lightfastness	7
More info	kvadrat.dk
Total no of colours	56



236
Camel

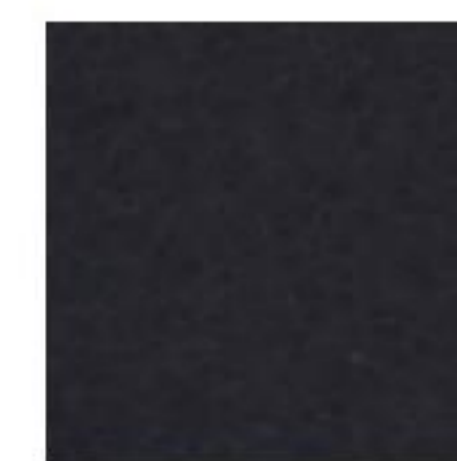

191
Jet black



346
Cognac



246
Cognac

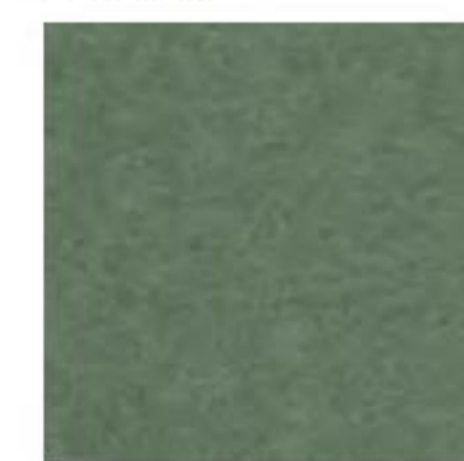

944
Olive



793
Navy blue

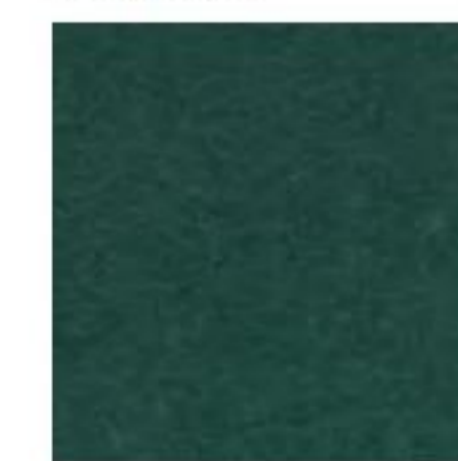

886
Ancient green

DIVINA MELANGE 3

Fabric Group 3



About	Classic wool felt used for furniture as well as clothing. Divina Melange 2 (melange yarns) are suitable for all upholstery. Domestic to moderate public use.
Application	A B C D E
Composition	100% wool
Martindale	45.000
Environment	EU Ecolabel
Flame resistance	AS/NZS 1530.3, BS 5852 Crib 5, BS 5852 part 1, BS 5867 part 2 type B, EN 1021-1/2, EN 13501, C-s1, d0, glued, IMO FTP Code 2010 Part 8, NF D 60 013, NFPA 260, SN 198 898 5.3 with treatment, UNI 9175 1IM, US Cal. Bull. 117-2013, ÖNORM B1/ Q1, BS 5852 ignition source 3
Pilling	3
Lightfastness	6-7
More info	kvadrat.dk
Total no of colours	24



220
Light sand

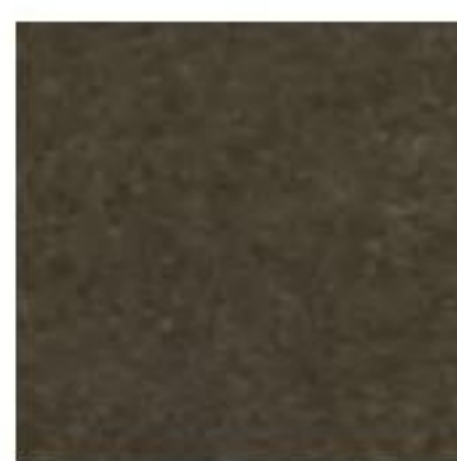

280
Dark brown



120
Cold grey



180
Charcoal



771
Dusty blue

FUSE

Fabric Group 5



About	Densely woven wool and cotton blend with a close pattern of ribbed stripes in which the weave creates rows of stich-like patterning.
Application	A C D E
Composition	65% wool, 23% wool, 8% viscose, 4% polyamide
Martindale	100.000
Environment	Sustainable resource
Flame resistance	BS 5852 Crib 5, BS 5852 part 1, DIN 4102 B2, EN 1021-1/2, IMO FTP Code 2010 Part 8, NF D 60 013, UNI 9175 1IM, US Cal. Bull. 117-2013, ÖNORM B1/ Q1
Pilling	3-4
Lightfastness	7
More info	kvadratrafsimons.com
Total no of colours	10



351
Clay



981
Ancient green

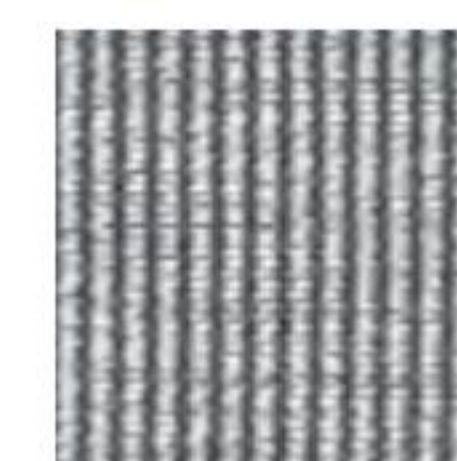

131
Cold grey



191
Navy blue

HALLINGDAL 65

Fabric Group 2



About	Classic wool-viscose blend with voluminous grip and a large scale of colour blends. Suitable for all upholstery. Designed by Nanna Ditzel in 1965.
Application	A B C D
Composition	70% wool, 30% viscose
Martindale	100.000
Environment	EU Ecolabel
Flame resistance	AS/NZS 1530.3, AS/NZS 3837, BS 5852 Crib 5, BS 5852 part 1, EN 1021-1/2, IMO FTP Code 2010 Part 8, NF D 60 013, NFPA 260, SN 198 898 5.3 with treatment, UNI 9175 1IM, US Cal. Bull. 117-2013, ÖNORM B1/ Q1, BS 5852 ignition source 3
Pilling	3
Lightfastness	7
More info	kvadrat.dk
Total no of colours	56



110
Light sand



224
Camel

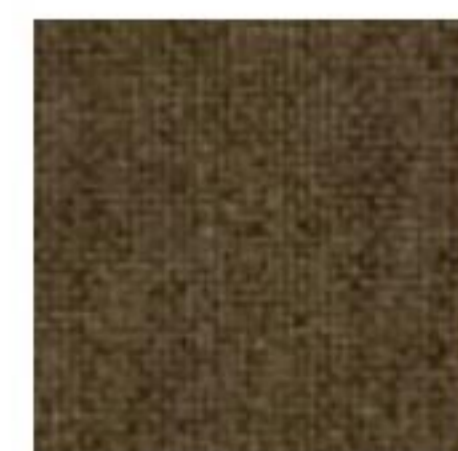

227
Clay



376
Dark brown



368
Dark brown



130
Cold grey



180
Charcoal

MOOD

Fabric Group 1



About	Wool fabric with a fluted surface structure. Natural and burnt colour shades.
Application	A B C D
Composition	92% wool, 8% polyamide
Martindale	90.000
Environment	EU Ecolabel
Flame resistance	BS EN 1021-2 Match, BS EN 1021-1 Cigarette, BS 5852 Part 1 0,1 Cigarette & match, BS 476 Part 7, class 1, Class Uno UNI 9175 Class 1 I EMME, CA TB 117-2013
Pilling	4
Lightfastness	5-7
More info	gabriel.dk
Total no of colours	31



4104
Camel

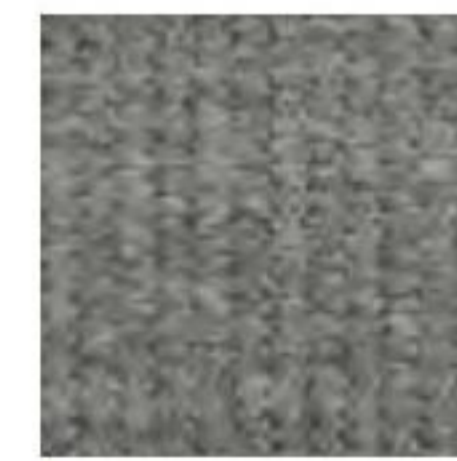

1102
Cold grey



2104
Charcoal



2107
Dusty blue



5105
Ancient green



4106
Ocean



1103
Powder nude



1105
Powder nude

NOISE

Fabric Group 5

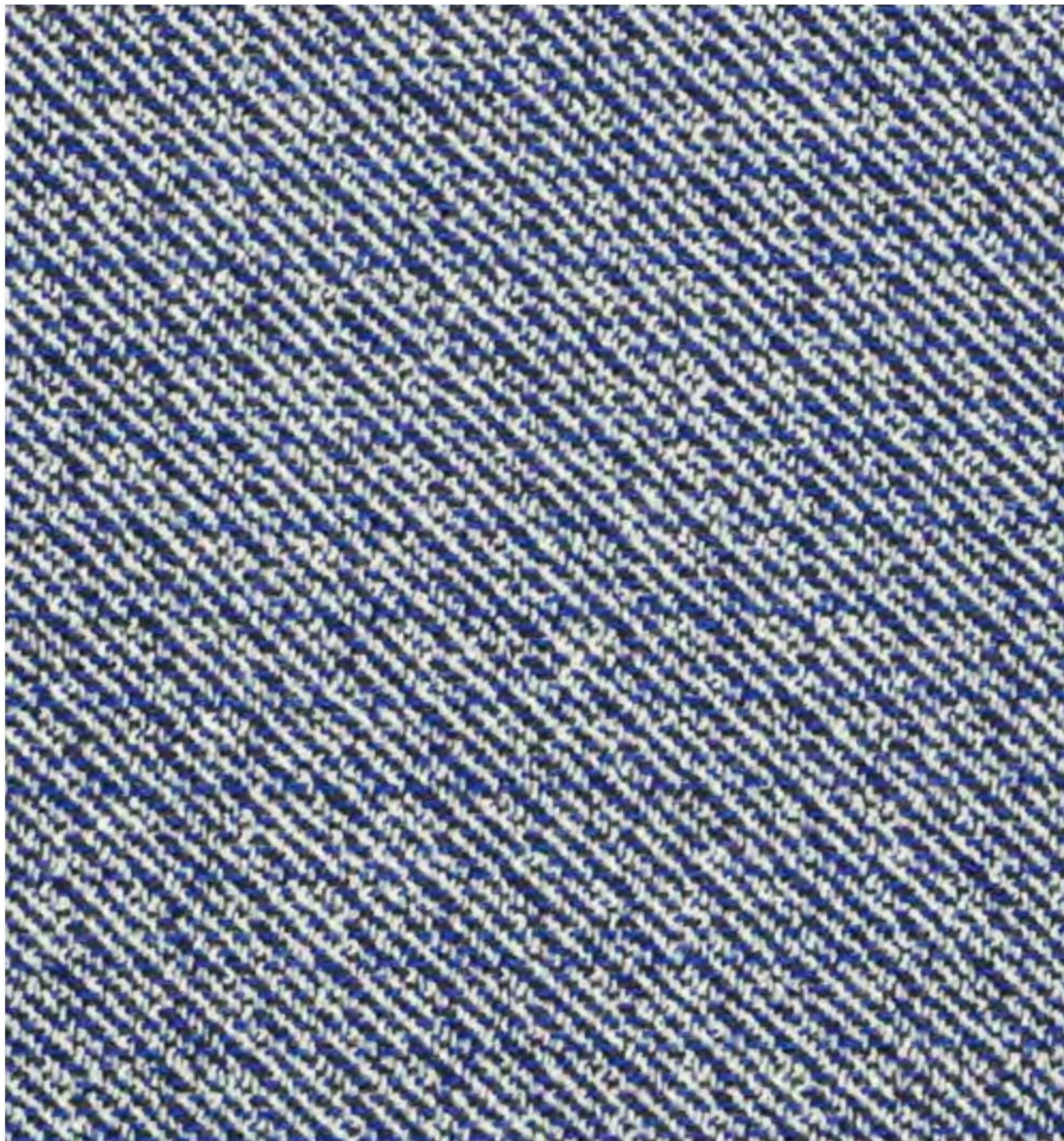

About	Wool blend in which strong diagonal stripes are broken up by flecks of sharp or neutral colours.
Application	A B C D
Composition	96% wool, 4% polyamide
Martindale	30.000
Environment	EU Ecolabel
Flame resistance	BS 5852 part 1, DIN 4102 B2, EN 1021-1/2, IMO FTP Code, 2010 Part 8, NF D 60 013, UNI 9175 1IM, US Cal. Bull. 117-2013, BS 5852 Crib 5 with treatment
Pilling	4
Lightfastness	6-7
More info	kvadratrafsimons.com
Total no of colours	10



132
Clay



222
Camel

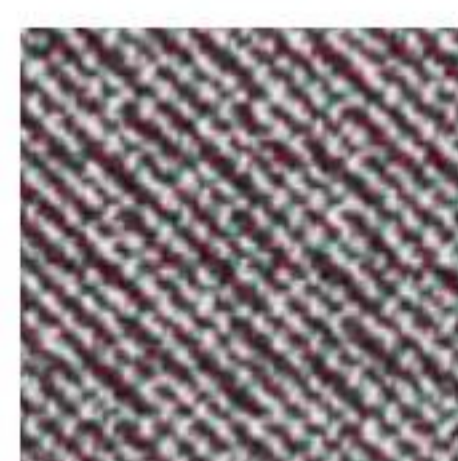

852
Deep red

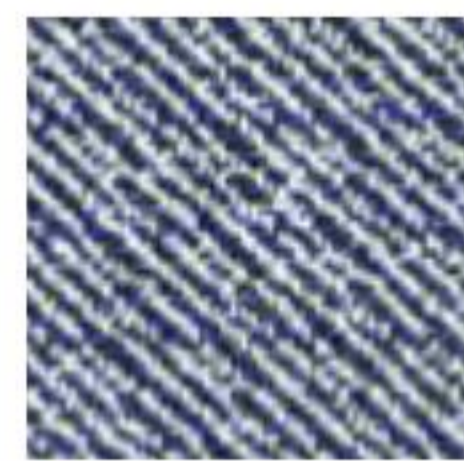

742
Navy blue

REFLEX

Fabric Group 5



About	Wool textile with 10cm-wide strips of embroidery executed in a slightly irregular yarn.
Application	A C D E
Composition	87% wool, 8% viscose, 5% polyamide
Martindale	100.000
Environment	Sustainable resource
Flame resistance	BS 5852 part 1, DIN 4102 B2, EN 1021-1/2, IMO FTP Code, 2010 Part 8, NF D 60 013, UNI 9175 1IM, US Cal. Bull., 117-2013, ÖNORM B2/Q1
Pilling	3-4
Lightfastness	7
More info	kvadratrafsimons.com
Total no of colours	10



339
Powder nude



159
Jet black



199
Jet black

STEELCUT TRIO 3

Fabric Group 2

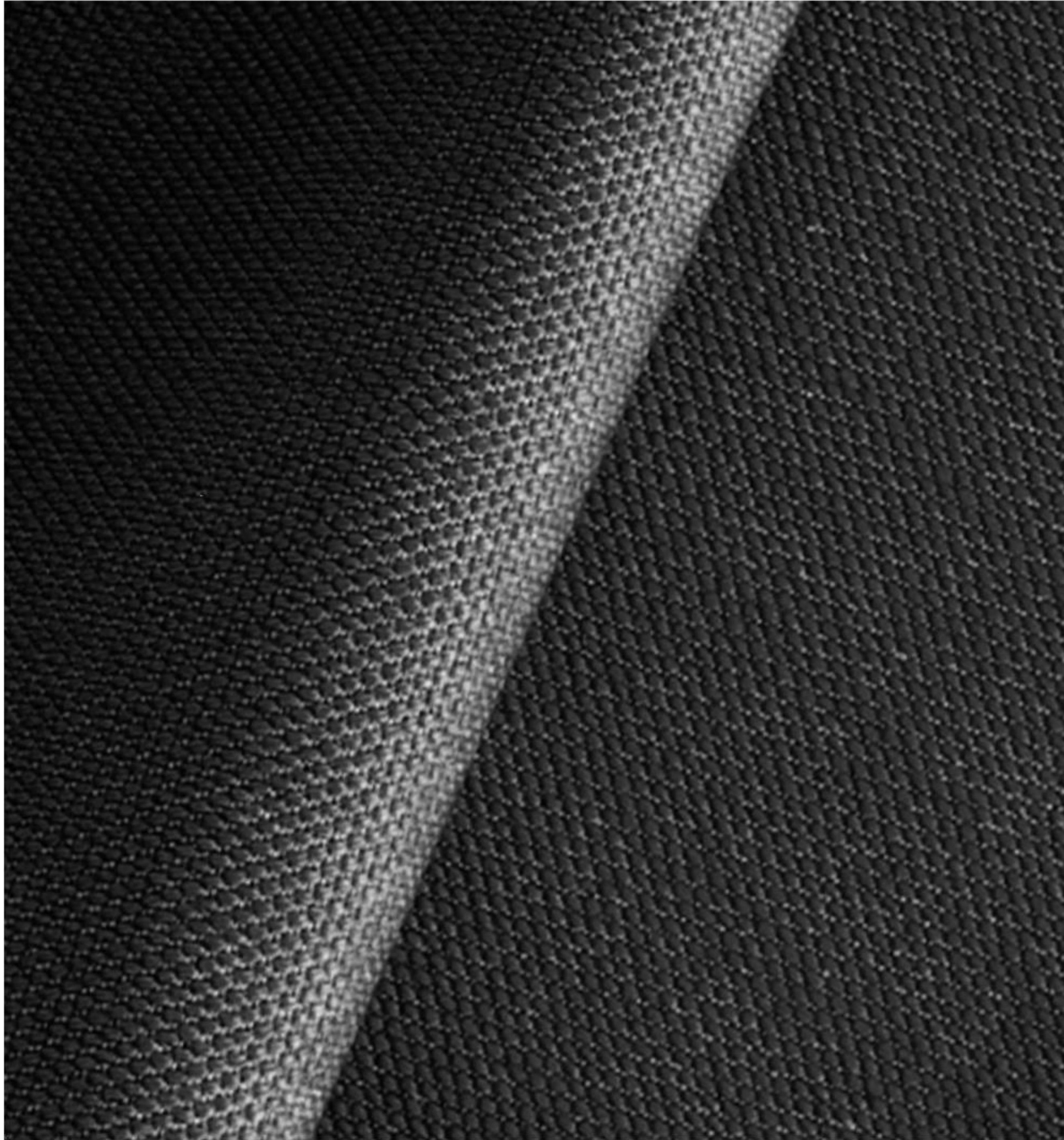

About	Tightly woven wool textile in three-colour mix.
Application	A B C D
Composition	90% wool, 10% polyamide
Martindale	100.000
Environment	EU Ecolabel
Flame resistance	AS/NZS 3837, class 2, BS 5852 part 1, EN 1021-1/2, IMO FTP Code 2010 Part 8, NF D 60 013, NFPA 260, SN 198 898 5.3 with treatment, UNI 9175 1IM, US Cal. Bull. 117-2013 ÖNORM B1/ Q1, BS 5852 Crib 5 with treatment, AS/NZS 1530.3, BS 5852 ignition source 3
Pilling	4
Lightfastness	5
More info	kvadrat.dk
Total no of colours	54



TONUS 4

Fabric Group 2



About	Classic plain-weave wool fabric with a comfortable soft touch and luxurious density.
Application	A B C
Composition	90% wool, 10% helanca
Martindale	100.000
Environment	EU Ecolabel
Flame resistance	AS/NZS 1530.3, BS 5852 part 1, EN 1021-1/2, IMO FTP Code 2010 Part 8, NF D 60 013, NFPA 260, SN 198 898 5.3 with treatment, UNI 9175 1IM, US Cal. Bull. 117-2013, ÖNORM B1/ Q1, BS 5852 Crib
Pilling	3
Lightfastness	6-7
More info	kvadrat.dk
Total no of colours	47



TWILL WEAVE

Fabric Group 3

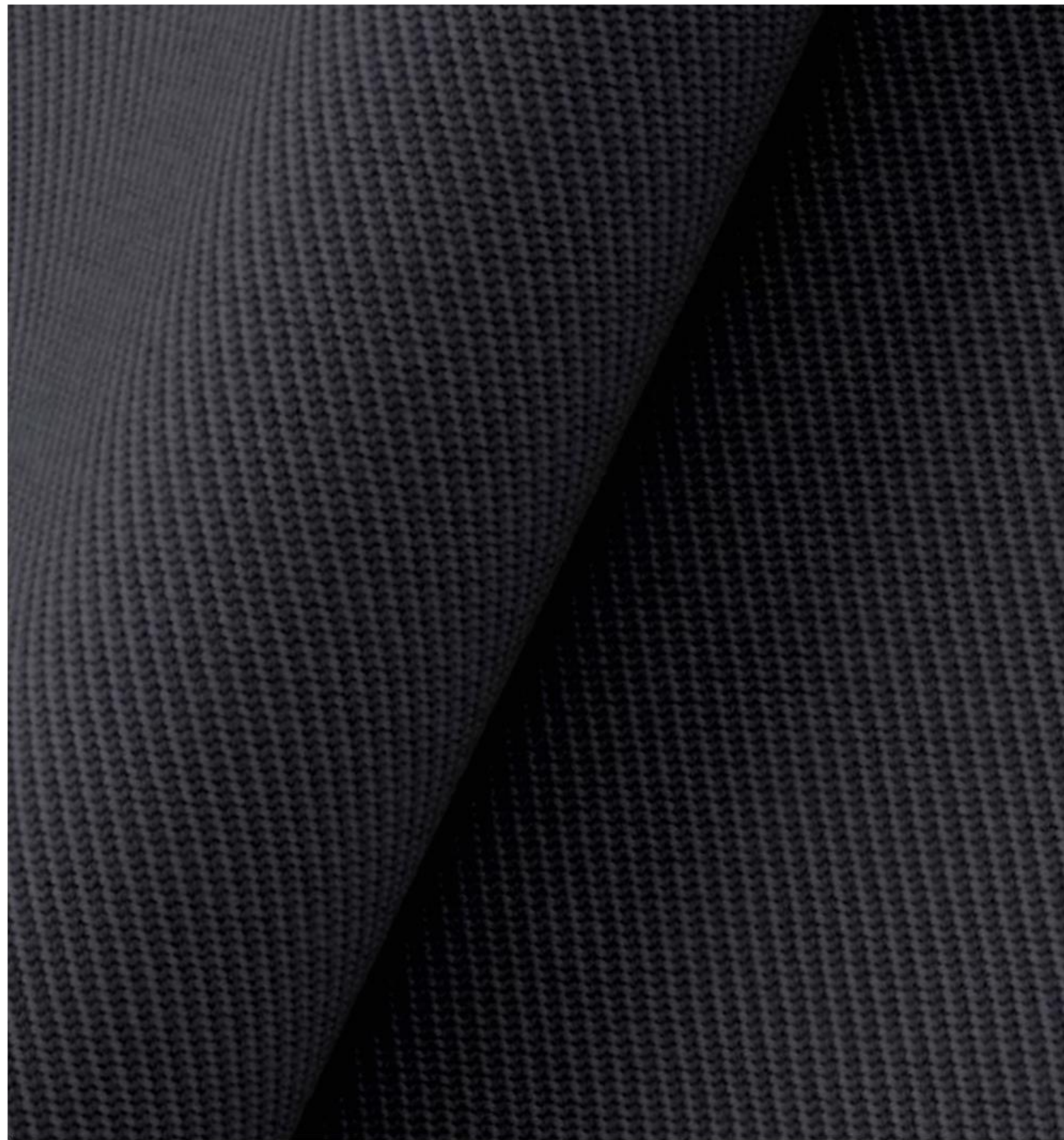

About	Classic twill textile woven in two related colours creating beautiful colourways. Large wool content creates a “heavy” textile with an elegant fit.
Application	A B C D E
Composition	90% wool, 10% polyamid
Martindale	60.000
Environment	EU Ecolabel
Flame resistance	AS/NZS 1530.3, BS 5852 ignition source 3, BS 5852 part 1, EN 1021-1/2, IMO FTP Code 2010 Part 8, US Cal. Bull., 117-2013, NF D 60 013, UNI 9175 1IM, BS 5852 Crib 5, SN 198 898 5.3 with treatment, AS/NZS 3837, class 3
Pilling	3-4
Lightfastness	6-7
More info	kvadrat.dk
Total no of colours	19

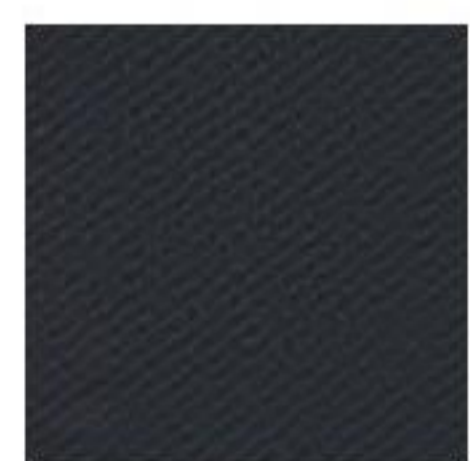

190
Charcoal



570
Deep red

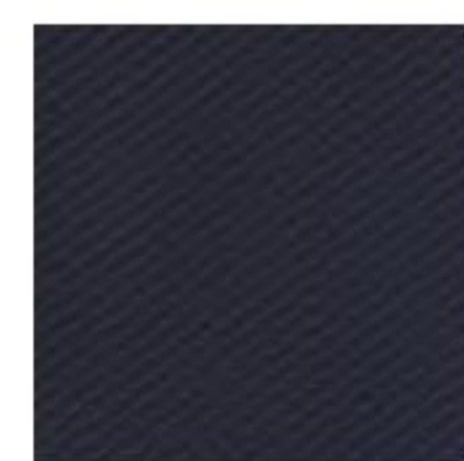

790
Navy blue



990
Ancient green



940
Ocean



530
Powder nude

VIDAR 3

Fabric Group 3

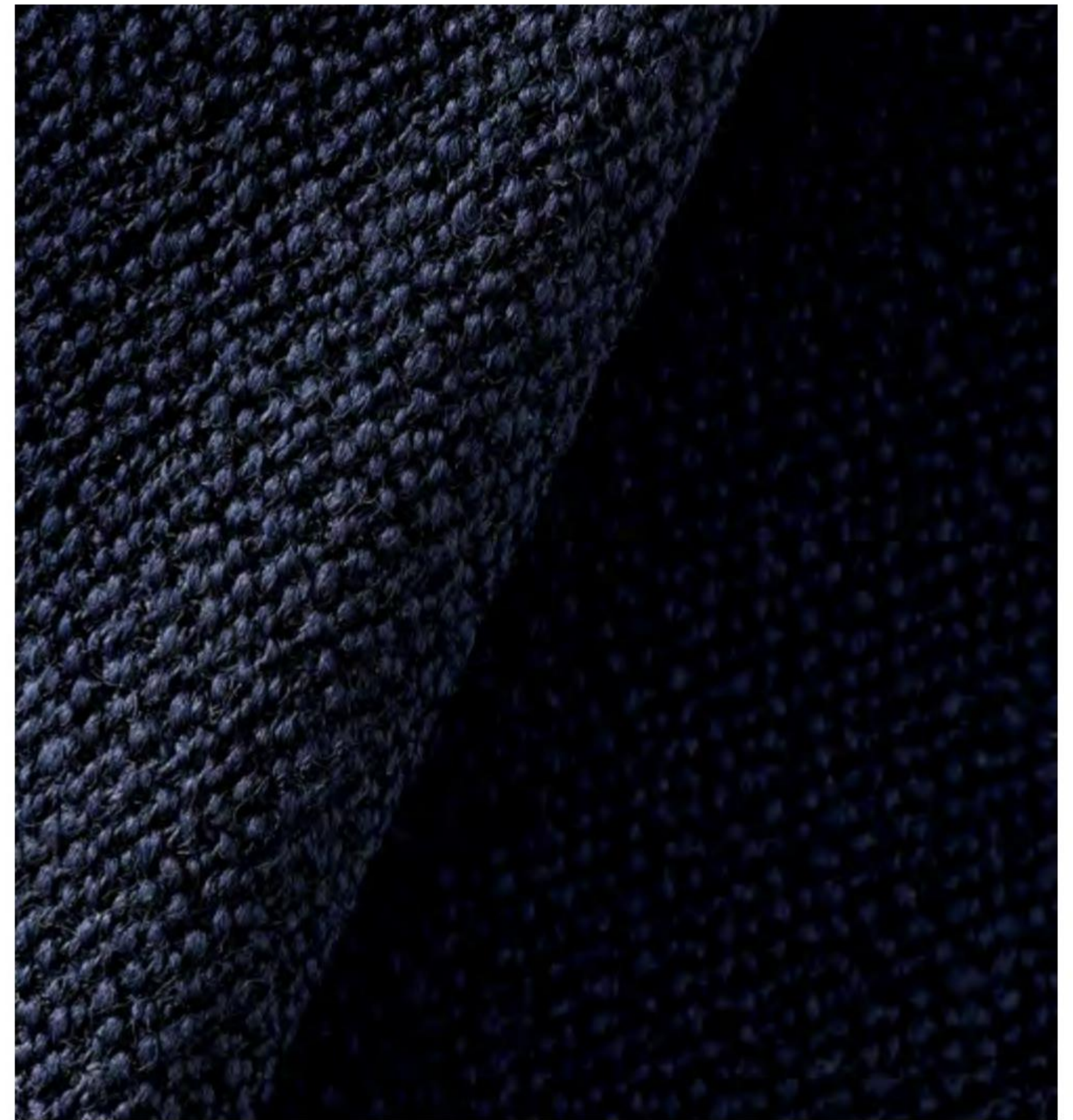

About	Elegant tightly woven wool textile with a matt, harmonious surface and a beautiful crepe texture.
Application	A B C D E
Composition	94% wool, 6% polyamide
Martindale	100.000
Environment	EU Ecolabel
Flame resistance	DIN 4102 B2, EN 1021-1/2, IMO FTP Code 2010 Part 8, NF D 60 013, UNI 9175 1IM, US Cal. Bull. 117-2013, BS 5852 part 1, NFPA 260, BS 5852 Crib 5
Pilling	4
Lightfastness	5-6
More info	kvadrat.dk
Total no of colours	31



333
Camel



353
Camel

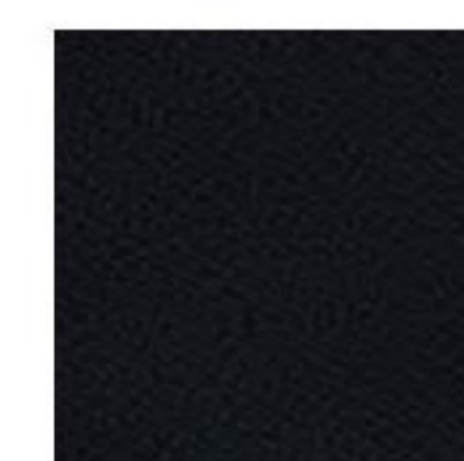

182
Charcoal

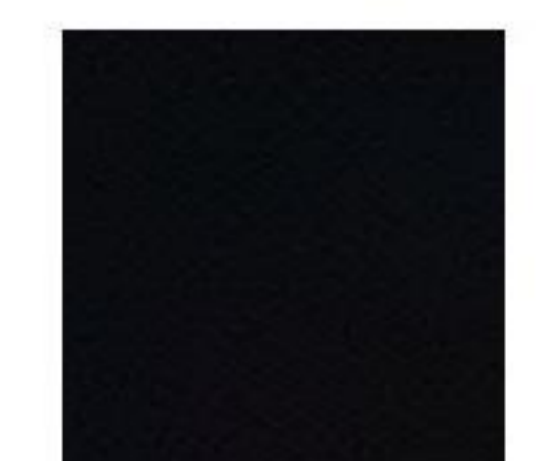

1880
Jet black



582
Deep red



472
Cognac



972
Olive

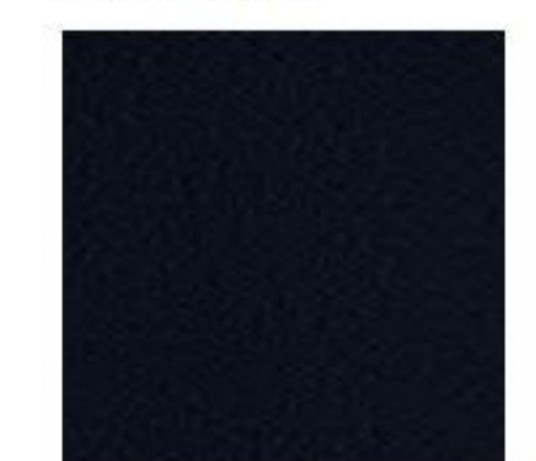

554
Navy blue



1062
Ancient green



733
Dusty blue

AGUILA

Fabric Group 2



About	Viscose- and cotton union with an outspoken woven structure that creates an Italian flair. Made in Italy and supplied directly to Fredericia.
Application	A B C D
Composition	60% viskose, 20% bomuld, 17% polyester, 3% linen
Martindale	90.000
Environment	Oeko-Tex
Flame resistance	BS 5852 : 2006 - Source 0, BS 5852 : 2006 - Source 1
Pilling	4
Lightfastness	5
More info	fredericia.com
Total no of colours	2



201
Light sand

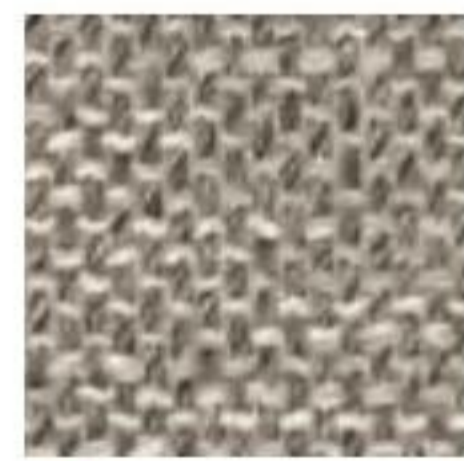

210
Light sand

MAPLE

Fabric Group 1



About	Viscose/linen chenille with a soft touch. Discrete two-tone colour shades.
Application	A B C D
Composition	81% viscose, 15% linen, 4% polyester
Martindale	30.000
Environment	Sustainable resource
Flame resistance	BS 5852 part 1, EN 1021-1/2, IMO FTP Code 2010 Part 8, BS 5852 Crib 5 with treatment, AS/NZS 1530.3, AS/NZS 3837, class 2, NFPA 260, US Cal. Bull. 117-2013
Pilling	4-5
Lightfastness	5
More info	kvadrat.dk
Total no of colours	26



222
Light sand

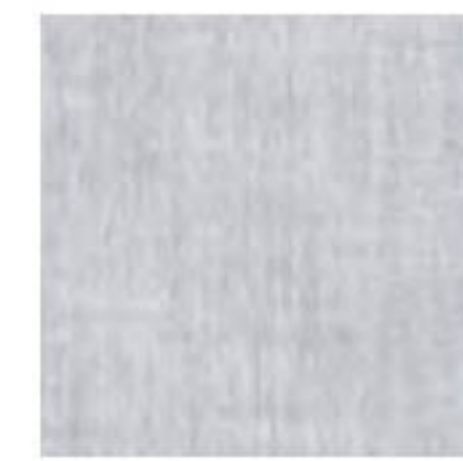

722
Cold grey

RUSKIN

Fabric Group 1



About	Soft and elegant textile combining viscose and linen creating motion and depth in the colourways. Discrete yet visible surface structure.
Application	A B C D E
Composition	70% viscose, 15% linen, 10% wool, 5% polyamide
Martindale	60.000
Environment	EU Ecolabel
Flame resistance	Bs 5852 Part 1 Ign 0, Bs 5852 Part 1 Ign 1 With Treatment, Bs 5852 Part 1 Exempt, Bs 5852 Part 2 Ign 5 Crib Contract Upholstery With Treatment
Lightfastness	5
More info	romo.com
Total no of colours	40



10
Light sand



15
Light sand



16
Cold grey



33
Clay



34
Charcoal

SONAR 3

Fabric Group 5



About	Sonar 3 is made of bouclé yarns. The dominant colours of the colourways are tempered by complementary and contrasting colors that create a vital and elegant overall effect. Not suitable for hard public use.
Application	A B C D E
Composition	59% wool, 25% viscose, 9% linen, 5% polyamide, 2% polyester
Martindale	20.000
Environment	Sustainable resource
Flame resistance	BS 5852 part 1, EN 1021-1/2, IMO FTP Code 2010 Part 8, UNI 9175 1IM, US Cal. Bull. 117-2013, BS 5852 Crib 5 with treatment, AS/NZS 3837, class 2
Pilling	3-4
Lightfastness	7
More info	kvadratrafsimons.com
Total no of colours	17



792
Navy blue



113
Powder nude

SAVANNA

Fabric Group 2



About	Mixed content webbed fabric with a "heavy grain" and natural colour shades.
Application	A B C D
Composition	34% polyester, 31% wool, 26% acrylic, 3% polyamide, 2% linen
Martindale	45.000
Flame resistance	BS 5852 part 1 with treatment, BS 5852 part 1, ig. s. 0, EN 1021-1/2, NF D 60 013 with treatment, SN 198 898 5.3 with treatment, US Cal. Bull. 117-2013, BS 5852 Crib 5
Pilling	3
Lightfastness	6-7
More info	kvadrat.dk
Total no of colours	12



122
Light sand



242
Clay



192
Charcoal

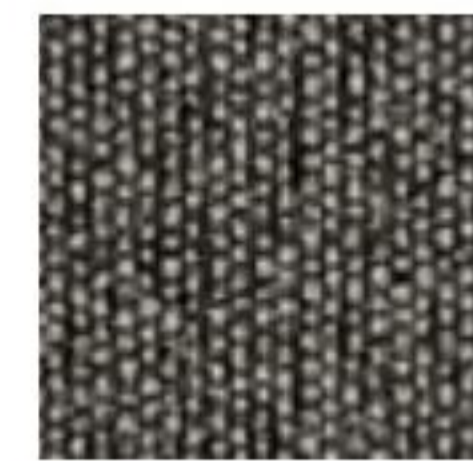

152
Jet black



622
Deep red

SUNNIVA 2

Fabric Group 2



About	Wool/viscose/linen mix with a classic look and natural shine. Natural and subtle colourways.
Application	A B C D E
Composition	58% wool, 25% viscose, 8% linen, 5% polyamide, 4% polyester
Martindale	50.000
Environment	Sustainable resource
Flame resistance	BS 5852 part 1, ig. s. 0, EN 1021-1/2, US Cal. Bull. 117-2013 NFPA 260, IMO FTP Code 2010 Part 8, AS/NZS 3837, class 2, BS 5852 Crib 5 with treatment
Pilling	3
Lightfastness	5-6
More info	kvadrat.dk
Total no of colours	24



717
Light sand



242
Cold grey



1079
Charcoal



172
Dusty blue



752
Dusty blue



192
Navy blue



132
Ocean

SINEQUANON

Fabric Group 3



About	Linen-viskose union with yarns in two-tone, creating a sophisticated colour range with a subtle shine. Comes with waterrepellent treatment which offers specific protection from liquids and oils. Not suitable for hard public use.
Application	A B C D E
Composition	60% viscose, 16% linen, 13% cotton, 6% polyacrylic, 5% polyester
Martindale	35.000
Flame resistance	BS 5852 PART 1 IGN 0 CIGARETTE, BS 5852 PART 1 IGN 1 MATCH
More info	dedar.com
Total no of colours	36



01
Light sand



37
Camel



25
Clay



02
Black brown



24
Olive



13
Navy blue



23
Ancient green



21
Ocean



16
Powder nude

TOSCA

Fabric Group 4



About	A rustic textile with structure woven from coarse yarns that combine linen and wool. Dyed with plant colors in natural tones.
Application	A B C D
Composition	63% linen, 29% wool, 5% polyamide, 3% cotton
Martindale	100.000
Flame resistance	BS 5852 PART 1 IGN 0 CIGARETTE, BS 5852 PART 1 IGN 1 MATCH, BS 5852 PART 2 IGN 5 CRIB CONTRACT UPHOLSTERY with treatment
Lightfastness	5
More info	romo.com
Total no of colours	24



04
Light sand



07
Clay



21
Camel

CARLOTTO

Fabric Group 2



About	Voluminous wool bouclé with a very soft surface and structure. High wear resistance and suitable for both private and public use. Made in Italy and supplied directly to Fredericia.
Application	A B C D
Composition	38% wool, 37% polyacrylic, 18% polyester, 7% cotton
Martindale	100.000
Environment	Oeko-Tex
Flame resistance	BS 5852 : 2006 - Source 0, BS 5852 : 2006 - Source 1
Pilling	4
Lightfastness	4-5
More info	fredericia.com
Total no of colours	6



COBBLESTONE

Fabric Group 4



About	A densely woven, chunky upholstery wool bouclé with a relaxed appearance. Suitable for all upholstery except for dominant pipings. Not suitable for public use.
Application	A B C D
Composition	75 % wool, 15% cotton, 10% polyamide
Martindale	40.000
Environment	Sustainable resource
Flame resistance	BS 5852 Part 1 Ign 0 Cigarette, BS 5852 Part 1 Ign 1 Match, BS 5852 Part 2 Ign 5 Crib Contract Upholstery
Lightfastness	5
More info	romo.com
Total no of colours	13



PILOT

Fabric Group 5

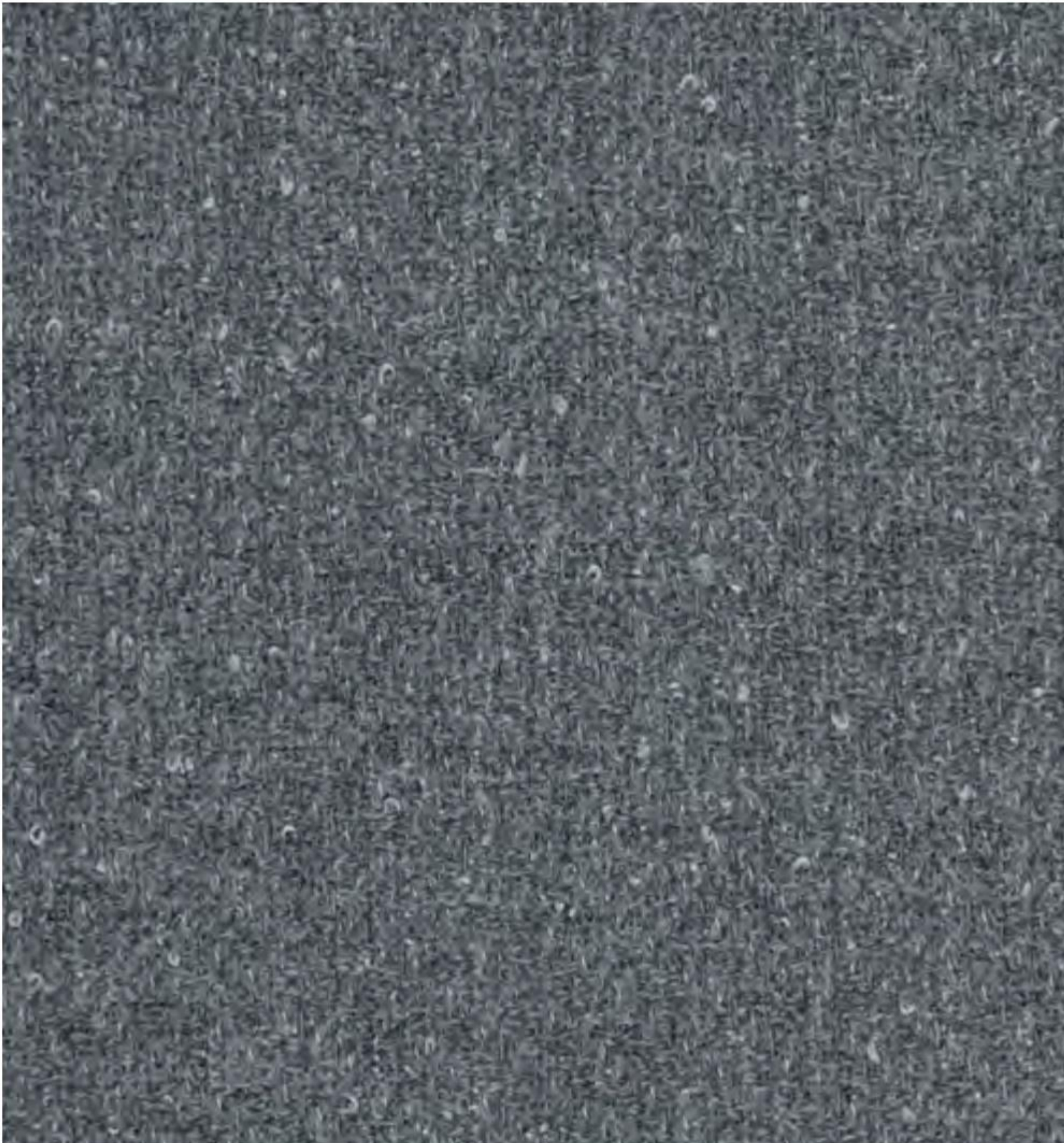

About	This bouclé fabric marries the softness and intense colour of merino wool to the lustre of contrasting yarns. Suitable for all upholstery.
Application	A B C D E
Composition	82% wool, 10% polyester, 8% polyamide1
Martindale	70.000
Environment	Sustainable resource
Flame resistance	BS 5852 part 1, DIN 4102 B2, EN 1021-1/2, IMO FTP Code 2010 Part 8, UNI 9175 1IM, US Cal. Bull. 117-2013, ÖNORM B1/ Q1, AS/NZS 3837, class 2, BS 5852 Crib 5
Pilling	4
Lightfastness	7
More info	kvadrat.dk
Total no of colours	10



132
Cold grey

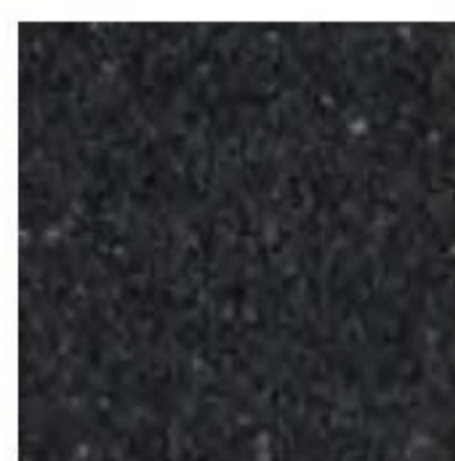

162
Charcoal



792
Navy blue

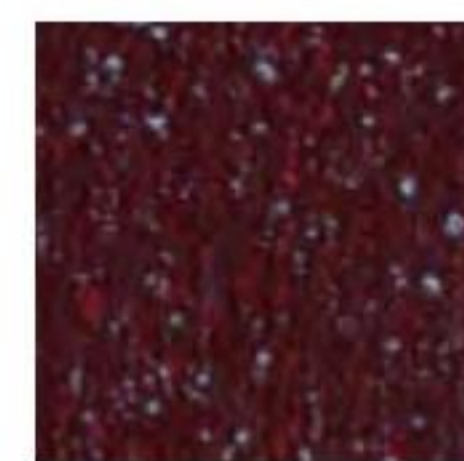

582
Dark red

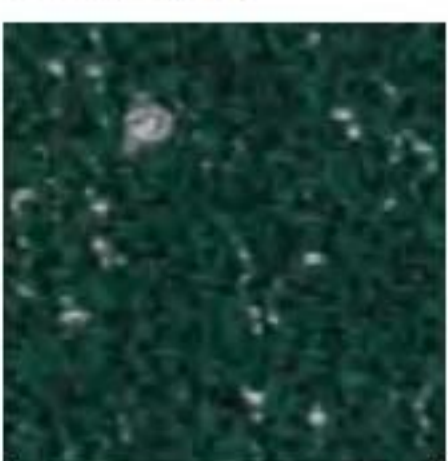

972
Ancient green

PULSAR

Fabric Group 5

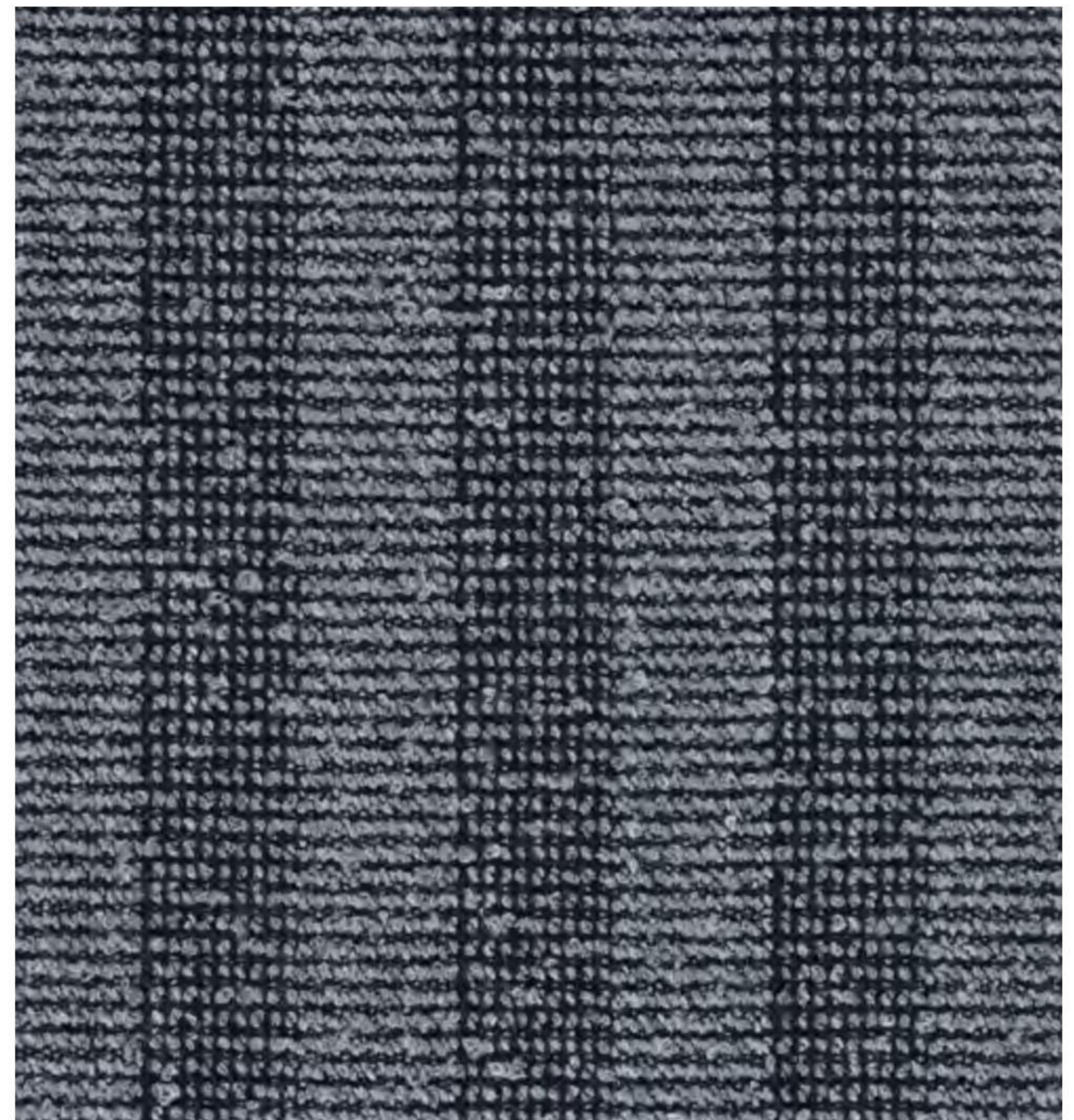

About	Bouclé combined with stripes, creating a pulsing pattern.
Application	A C D E
Composition	90% wool, 8% polyamide, 2% polyester
Martindale	100.000
Environment	Sustainable resource
Flame resistance	BS 5852 part 1, DIN 4102 B2, EN 1021-1/2, IMO FTP Code, 2010 Part 8, NF D 60 013, UNI 9175 1IM, US Cal. Bull., 117-2013, ÖNORM B1/ Q1, BS 5852 Crib 5 with treatment
Pilling	4
Lightfastness	7
More info	Kvadrat.dk
Total no of colours	11



169
Cold grey

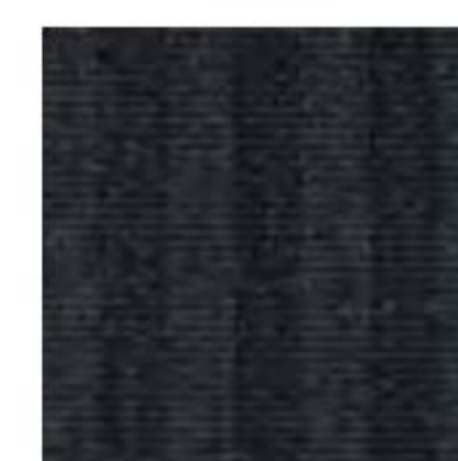

179
Charcoal



189
Navy blue

BYRAM

Fabric Group 5

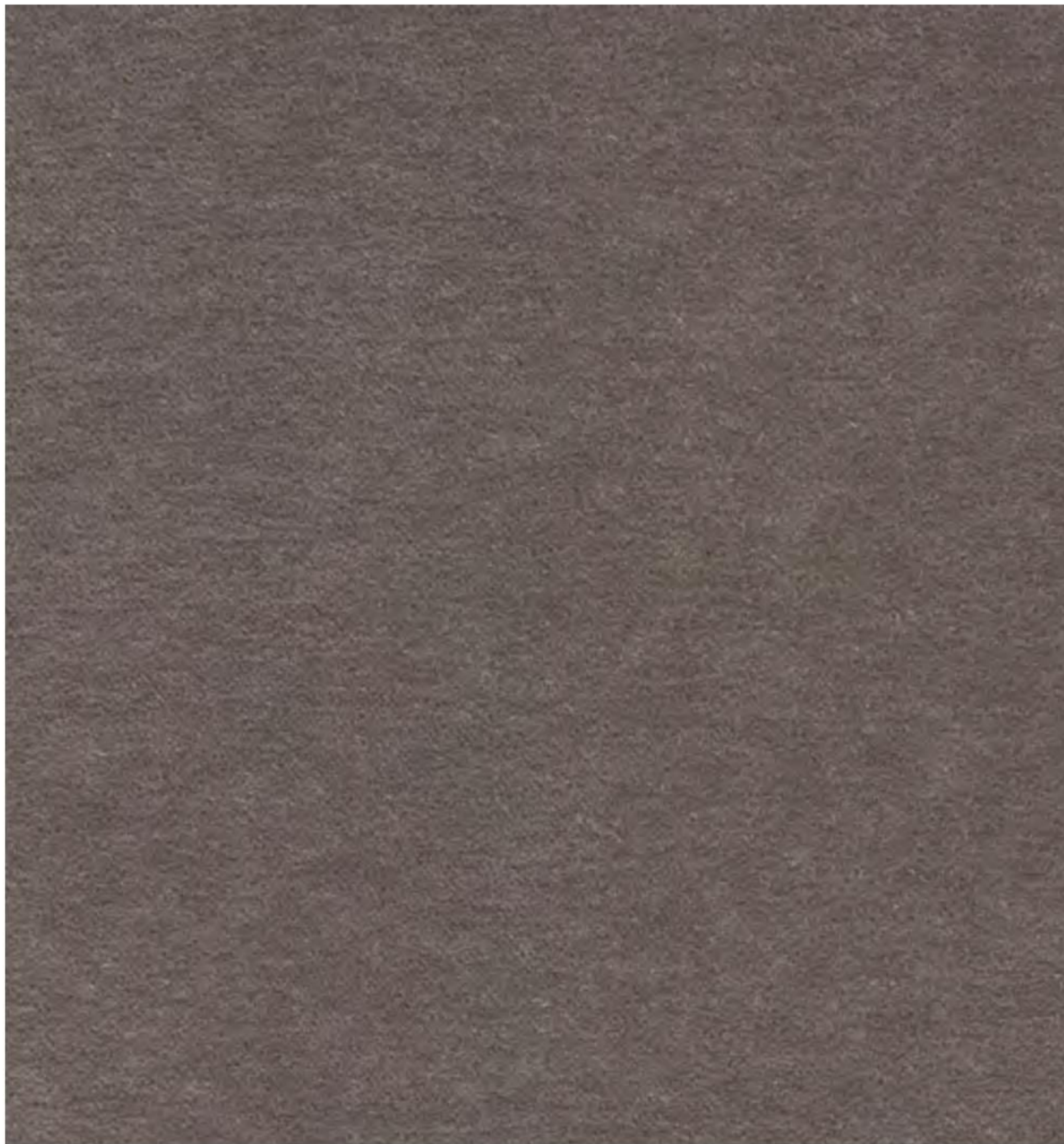

About	Mohair velor with a very close pile that gives a great color depth. Suitable for all upholstery, but not on prominent pipings.
Application	A B C D
Composition	65% wool, 23% cotton, 8% viscose, 4% polyamide
Martindale	70.000
Environment	Sustainable resource
Flame resistance	AS/NZS 1530.3, BS 5852 Crib 5, BS 5852 part 1, BS 5867 part 2 type B, EN 1021-1/2, IMO FTP Code 2010 Part 8, NF D 60 013, UNI 9175 1IM, US Cal. Bull. 117-2013, SN 198 898 5.3 with treatment
Pilling	4-5
Lightfastness	4
More info	kvadrat.dk
Total no of colours	19

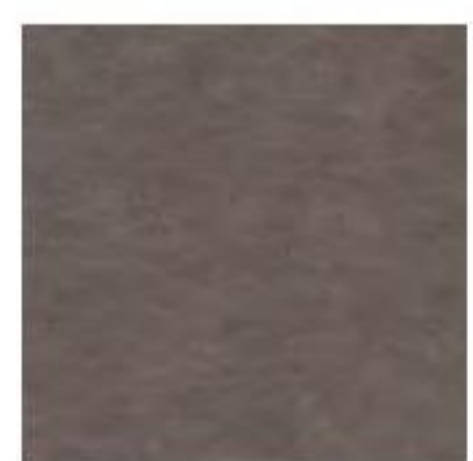

361
Clay

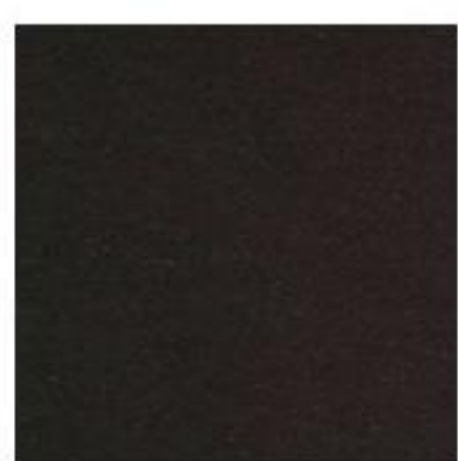

391
Dark brown

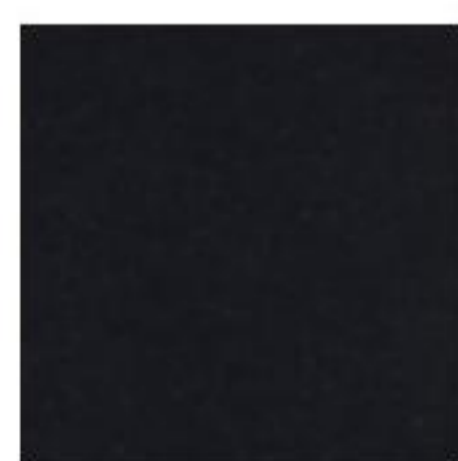

191
Jet black



981
Olive



171
Dusty blue



791
Navy blue

GRAND MOHAIR

Fabric Group 4



About	Mohair velvet with a tight and elegant pile. Suitable for all upholstery except for dominant pipings.
Application	A B
Composition	100% mohair (pile), 100% cotton (base)
Martindale	+100.000 (Wyzenbeek)
Environment	Oeko-tex
Flame resistance	Cal 117-2013, NFPA 260, Class 1, BS 5852: 2006, clause 11, Crib 5, EN 1021, 1 & 2, IMO A. 652
Pilling	-
Lightfastness	4-5
More info	daw.dk
Total no of colours	36



2001
Camel



9103
Olive



2103
Cognac



2600
Cognac

COMFORT +

Fabric Group 3



About	Microfibre textile with a gentle surface and large colour scale. Anti-static and flame retardant backing.
Application	A B C
Composition	88% polyester, 12% polyethane
Martindale	100.000
Environment	Oeko-Tex
Flame resistance	BS 5852 Part 1 0,1 Cigarette & match, BS EN 1021 1&2 Cigarette and Match, BS EN 1021-1 Cigarette, ÖNORM B 3825-B2-3800-Q1 UK, NF P 92-503 M3, CA TB 117-2013
Pilling	5
Lightfastness	5-7
More info	gabriel.dk
Total no of colours	77



GRID

Fabric Group 2



About	Special union between linen, polyester and polyamide gives a naturally flame retardant technical fabric with beautiful natural colourways.
Application	A B C D
Composition	67% polyamide, 17% linen, 16% polyester
Martindale	50.000
Environment	Oeko-Tex
Flame resistance	BS 5852 Part 0+1
Pilling	4
Lightfastness	5-6
More info	almedahls.se
No of colours	24



MERIT

Fabric Group 2



About	Innovative textile made of 76% recycled polyester. Out-spoken yet harmonious surface structure in dual colours.
Application	A B C
Composition	76% recycled polyester, 24% new polyester
Martindale	100.000
Environment	Greenguard Certification
Flame resistance	BS 476 part 7 + 6 with treatm, BS 5852 Crib 5 with treatment, BS 5852 part 1 with treatment, EN 1021-1/2, US Cal. Bull. 117-2013
Pilling	4
Lightfastness	7
More info	kvadrat.dk / maharam.com
Total no of colours	43



OAK SOAP



About Soap treatment is a finish that leaves the surface as raw and natural as possible. The natural oils of the soap gently seal the wood and gives it some stain resistance, however a new soap treatment must be applied from time to time to maintain the appearance. Soaped oak is light when new and darkens over time. Oak has a relatively open surface with a visible grain structure, where beautiful flecking is an effect that can naturally occur in solid oak.

OAK LACQUERED



About European oak. A light lacquer treatment partially fills the grain, so the wood structure can be seen on the surface. Oak has a relatively open surface with a visible grain structure. This light lacquer treatment is gentler than a dense lacquer, consequently scratches will not be easily exposed. The wood itself has a nice tactile feel and the natural ageing over time will be more beautiful. A delicate white pigment is added to the lacquer to maintain the light appearance of the oak. Flecking is a lovely effect that can naturally occur in solid oak.

OAK OILED



About Oil treatment enhances the warm tones of oak. The oil used is a clear, natural oil with beeswax. This seals the surface to make it water and stain resistant, thus minimising any visible marks. The oil is absorbed into the wood and creates a smooth surface with a silky touch. Over time, the oil will dry out and new oil must be applied to avoid a dull surface. Oak has a relatively open surface with a visible grain structure. Beautiful flecking is an effect that can naturally occur in solid oak.

SMOKED OAK, OILED



About European oak. Smoked oak with oil treatment is only used for solid wood. The oak is fumed in special steam that darkens the surface and makes the colour browner. Different parts of the solid oak absorb the fume to different degrees and colour differences will naturally occur. After fuming, the oil treatment further enhances the warm tones of the oak. The oil used is a clear, natural oil with beeswax. This seals the surface to make it water and stain resistant, thus minimising any visible marks. Over time, the oil will dry out and new oil must be applied to avoid a dull surface. Beautiful flecking is an effect that can naturally occur in solid oak.

SMOKED OAK STAINED, LACQUERED



About European oak. Smoked oak stained is a stain treatment that resembles the colour of smoked oak. It is used in furniture where the natural variation in wood requires a more harmonious result than what fumed smoked oak can offer. Frederica uses a stain solution that enhances the warm tones of the oak and reveals the natural wood structure. After staining, the wood is covered with a delicate layer of lacquer. As a result, smoked oak stained is easy to maintain and able to resist stains and water quite well.

GREY OAK STAINED, LACQUERED



About European oak. A stain treatment that reveals the wood structure whilst adding grey tones to the surface. After staining, the wood is covered with a delicate layer of lacquer. As a result, grey oak stained is easy to maintain and able to resist stains and water quite well.

LIGHT GREY OAK STAINED, LACQUERED



About European oak. A stain treatment that reveals the wood structure whilst adding light grey tones to the surface. After staining, the wood is covered with a delicate layer of lacquer. As a result, light grey oak stained is easy to maintain and able to resist stains and water quite well.

BLACK LACQUERED



About Black lacquer in RAL 9005 colour. After the black lacquer is applied to oak or ash, the grain structure of both will be visible. Applied to beech, the surface structure becomes more harmonious, where the visible grain structure is limited.

WHITE ASH



About Painted white ash RAL 9016. Ash is chosen for its surface structure, which is visible after applying the paint. Applied to beech, the surface structure becomes more harmonious, where the visible grain structure is limited.

BEECH SOAP

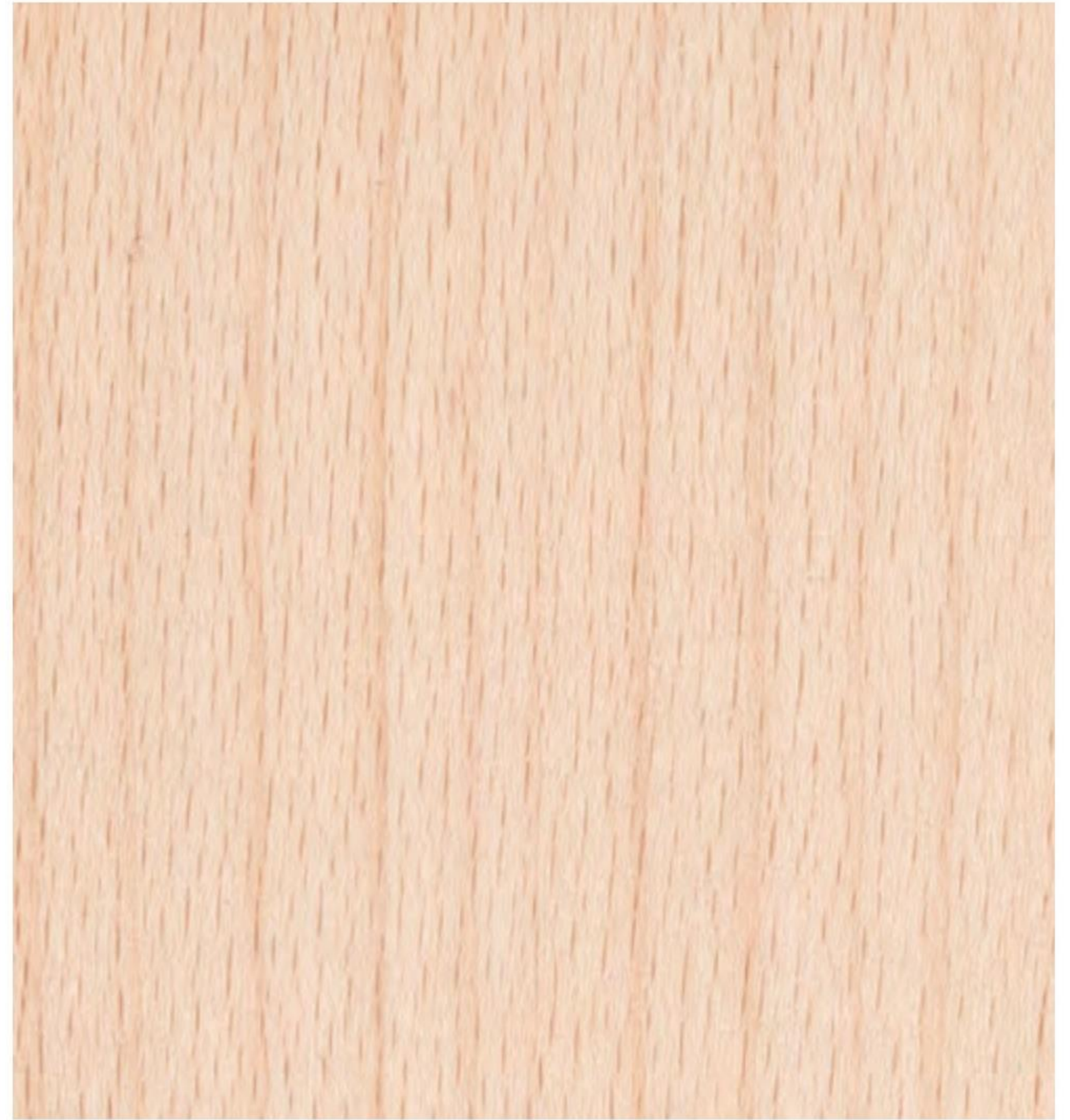

About European beech. Soap treatment is a finish that leaves the surface as raw and natural as possible. The natural oils of the soap gently seal the wood and gives it some stain resistance, however new soap must be applied from time to time to maintain the appearance. Soaped beech is light when new and darkens over time. Beech has a tight and harmonious surface structure with a smooth tactile feel.

WALNUT LACQUERED



About American walnut with a tight, "closed" surface structure. A light lacquer treatment that partially fills the grain is applied to seal the surface and make it stain and water resistant. This light lacquer treatment is gentler than a dense lacquer, consequently scratches will not be easily exposed. The wood itself has a nice tactile feel and the natural ageing over time will be more beautiful. The lacquer applied to walnut is clear without any colour pigment.

BEECH LACQUERED



About European beech has a tight and harmonious surface structure. A light lacquer treatment partially fills the grain so the wood structure can be seen on the surface. Oak has a relatively open surface with a visible grain structure. This light lacquer treatment is gentler than a dense lacquer, consequently scratches will not be easily exposed. The wood itself has a nice tactile feel and the natural ageing over time will be more beautiful. A delicate white pigment is added to the lacquer to maintain the light appearance of the beech.