

LAURENT FIREPLACE

WITH NEO AUTOMATIC ETHANOL BURNER

Net Zero fireplace with BEV Technology®

AUTOMATIC BURNER

The automatic burner with the patented BEV Technology® is the most advanced product in the industry ensuring the cleanest burning process without any smoke, smell or ash. The flame is produced by combusting ethanol vapours and has no direct contact with the liquid fuel. Additionally, the burner is decorated with glass foam granulate.



AUTOMATIC REFILLING SYSTEM

The automatic pump communicates with the device, delivering the necessary amount of fuel. There is no risk of overfilling the tank or spilling the fuel.



REMOTE CONTROL

Take full control over the fireplace with the intuitive and minimalistic remote in your hand.

SINTERED CERAMIC BOX

The box is made of a highly-renowned Dekton surface by Cosentino – a 12mm thick ultra-compact material made from sintered ceramics, quartz and glass. Utilizing only natural materials, the surface is entirely carbon-neutral and eco-friendly. Its high-performance offers scratch and stain resistance and is known to withstand high temperatures. It has an elegant matte look of Laurent marble, making it an eye-catching decoration in any interior space.

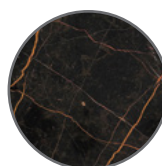

FLAME CONTROL

Have control over the fire and take advantage of the 6-stage flame height

SAFETY SENSORS

- Heat/temperature sensor
- Fuel spillage sensor
- Fuel level sensor

Laurent Fireplace

with Neo Burner

Fuel tank capacity	2.6 L
Maximum burn time	4.5 hours
Maximum heat output	5 kW
Minimum room cubature	50 m ³
Flame height regulation	2 stages
Weight	68.5 kg
Fuel type	bioethanol 95 - 96,6%
Flue	not required
Air change rate	1 space volume per hour
Power supply	230 V
Finish	Laurent Dekton, black powder coating
Materials	sintered ceramics, steel, galvanized steel, toughened glass
Application	for indoor use only

CONTROL OPTIONS



included

OPTIONAL GRATE AND LOGS

Add a touch of a traditional look to the burner with the optional decorative grate

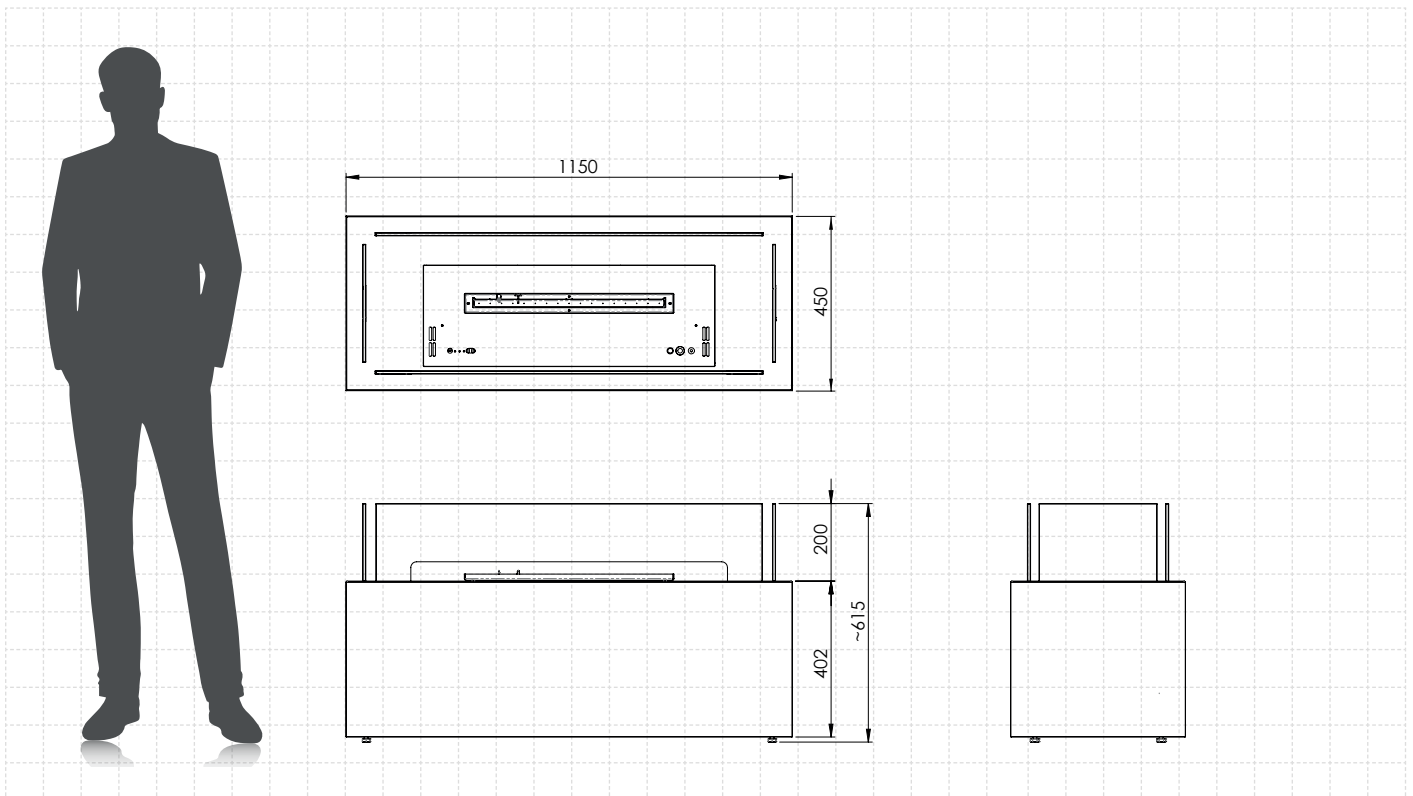

All product specifications and data are subject to change without notice and are believed to be accurate as of the date hereof. Planika Sp. z o.o., its affiliates, agents, and employees, and all persons acting on its or their behalf (collectively, "Planika Sp. z o.o."), disclaim any and all liability for any errors, inaccuracies or incompleteness contained in any document or in any other disclosure relating to any product. To the maximum extent permitted by applicable law, Planika Sp. z o.o. disclaims any and all liability arising out of the application or use of any product. This document does not expand or otherwise modify Planika Sp. z o.o.'s terms and conditions of purchase, including but not limited to the warranty expressed therein. No license, express or implied, by estoppel or otherwise, to any intellectual property rights is granted by this document or by any conduct of Planika Sp. z o.o.. Customers using or selling Planika Sp. z o.o.'s products not expressly indicated for use in such applications do so entirely at their own risk and agree to fully indemnify Planika Sp. z o.o. for any damages arising or resulting from such use or sale. The images are indicative only.

LAURENT FIREPLACE

WITH PRIME FIRE 700 AUTOMATIC ETHANOL BURNER

Net Zero fireplace with BEV Technology®

AUTOMATIC BURNER

The automatic burner with the patented BEV Technology® is the most advanced product in the industry ensuring the cleanest burning process without any smoke, smell or ash. The flame is produced by combusting ethanol vapours and has no direct contact with the liquid fuel.

AUTOMATIC REFILLING SYSTEM

The automatic pump communicates with the device, delivering the necessary amount of fuel. There is no risk of overfilling the tank or spilling the fuel.



SINTERED CERAMIC BOX

The box is made of a highly-renowned Dekton surface by Cosentino – a 12mm thick ultra-compact material made from sintered ceramics, quartz and glass. Utilizing only natural materials, the surface is entirely carbon-neutral and eco-friendly. Its high-performance offers scratch and stain resistance and is known to withstand high temperatures. It has an elegant matte look of Laurent marble, making it an eye-catching decoration in any interior space.

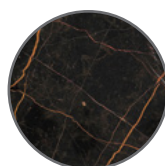

REMOTE CONTROL

Take full control over the fireplace with the intuitive and minimalistic remote in your hand.

FLAME CONTROL

Have control over the fire and take advantage of the 6-stage flame height

SAFETY SENSORS

- Heat/temperature sensor
- Fuel spillage sensor
- Fuel level sensor

Laurent Fireplace

with Prime Fire 700 Burner

Fuel tank capacity	1.9 L
Maximum burn time	4.5 hours
Maximum heat output	4.4 kW
Minimum room cubature	44 m ³
Flame height regulation	2 stages
Weight	66.3 kg
Fuel type	bioethanol 95 - 96,6%
Flue	not required
Air change rate	1 space volume per hour
Power supply	230 V
Finish	Laurent Dekton, black powder coating
Materials	sintered ceramics, steel, galvanized steel, toughened glass
Application	for indoor use only

CONTROL OPTIONS



included

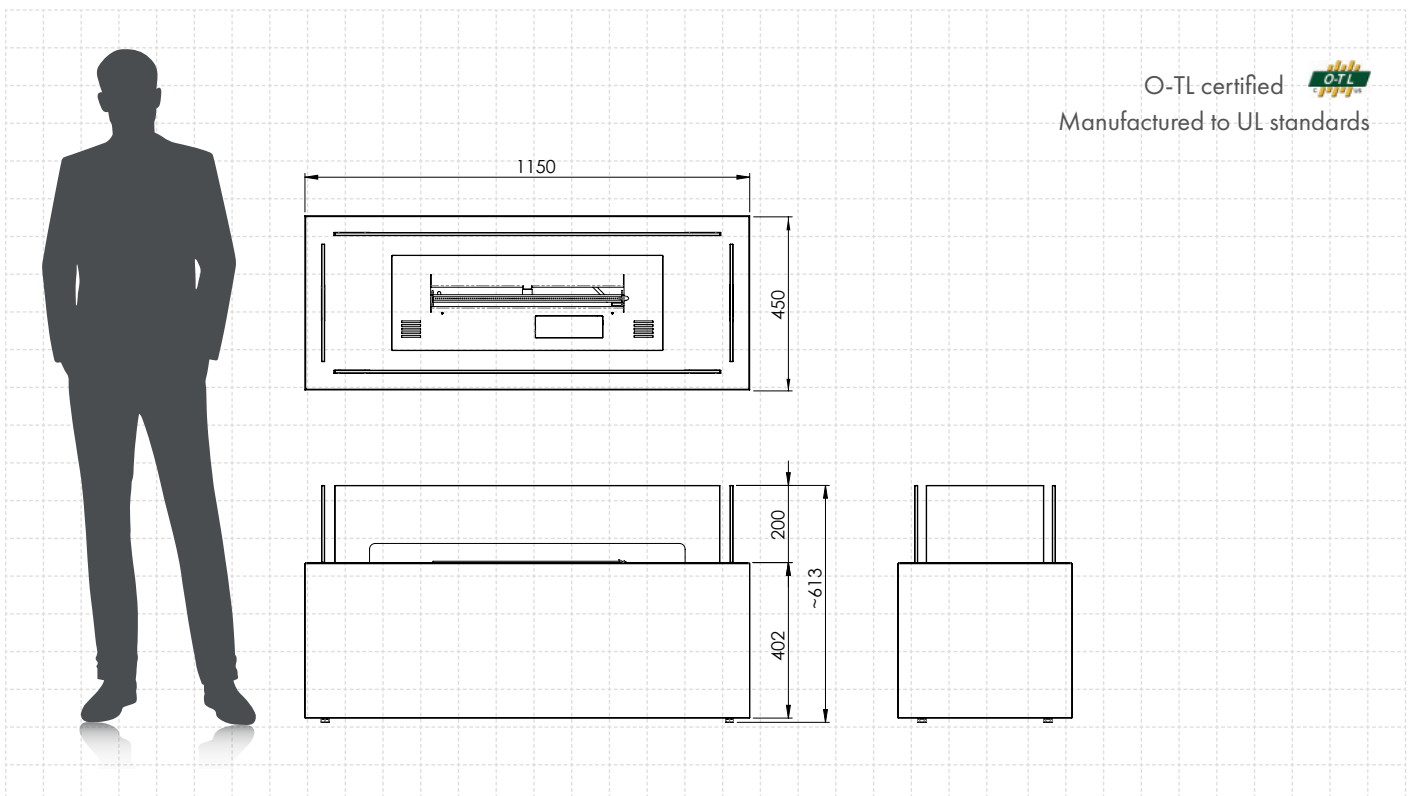

O-TL certified 
Manufactured to UL standards

All product specifications and data are subject to change without notice and are believed to be accurate as of the date hereof. Planika Sp. z o.o., its affiliates, agents, and employees, and all persons acting on its or their behalf (collectively, "Planika Sp. z o.o."), disclaim any and all liability for any errors, inaccuracies or incompleteness contained in any document or in any other disclosure relating to any product. To the maximum extent permitted by applicable law, Planika Sp. z o.o. disclaims any and all liability arising out of the application or use of any product. This document does not expand or otherwise modify Planika Sp. z o.o.'s terms and conditions of purchase, including but not limited to the warranty expressed therein. No license, express or implied, by estoppel or otherwise, to any intellectual property rights is granted by this document or by any conduct of Planika Sp. z o.o.. Customers using or selling Planika Sp. z o.o.'s products not expressly indicated for use in such applications do so entirely at their own risk and agree to fully indemnify Planika Sp. z o.o. for any damages arising or resulting from such use or sale. The images are indicative only.

LAURENT FIREPLACE

WITH PRIME FIRE 990+ AUTOMATIC ETHANOL BURNER

Net Zero fireplace with BEV Technology®

AUTOMATIC BURNER

The automatic burner with the patented BEV Technology® is the most advanced product in the industry ensuring the cleanest burning process without any smoke, smell or ash. The flame is produced by combusting ethanol vapours and has no direct contact with the liquid fuel.

AUTOMATIC REFILLING SYSTEM

The automatic pump communicates with the device, delivering the necessary amount of fuel. There is no risk of overfilling the tank or spilling the fuel.



SINTERED CERAMIC BOX

The box is made of a highly-renowned Dekton surface by Cosentino – a 12mm thick ultra-compact material made from sintered ceramics, quartz and glass. Utilizing only natural materials, the surface is entirely carbon-neutral and eco-friendly. Its high-performance offers scratch and stain resistance and is known to withstand high temperatures. It has an elegant matte look of Laurent marble, making it an eye-catching decoration in any interior space.

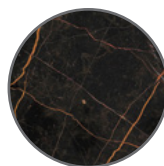

REMOTE CONTROL

Take full control over the fireplace with the intuitive and minimalistic remote in your hand.

FLAME CONTROL

Have control over the fire and take advantage of the 6-stage flame height

SAFETY SENSORS

- Heat/temperature sensor
- Fuel spillage sensor
- Fuel level sensor

Laurent Fireplace

with Prime Fire 990+ Burner

Fuel tank capacity	5.5 L
Maximum burn time	10 hours
Maximum heat output	7.0 kW
Minimum room cubature	70 m ³
Flame height regulation	2 stages
Weight	81.5 kg
Fuel type	bioethanol 95 - 96,6%
Flue	not required
Air change rate	1 space volume per hour
Power supply	230 V
Finish	Laurent Dekton, black powder coating
Materials	sintered ceramics, steel, galvanized steel, toughened glass
Application	for indoor use only

CONTROL OPTIONS



included

OPTIONAL DECORATIVE TRAY

Decorative tray with 2 ceramic logs or white stones installed on the burner, behind the fireline.

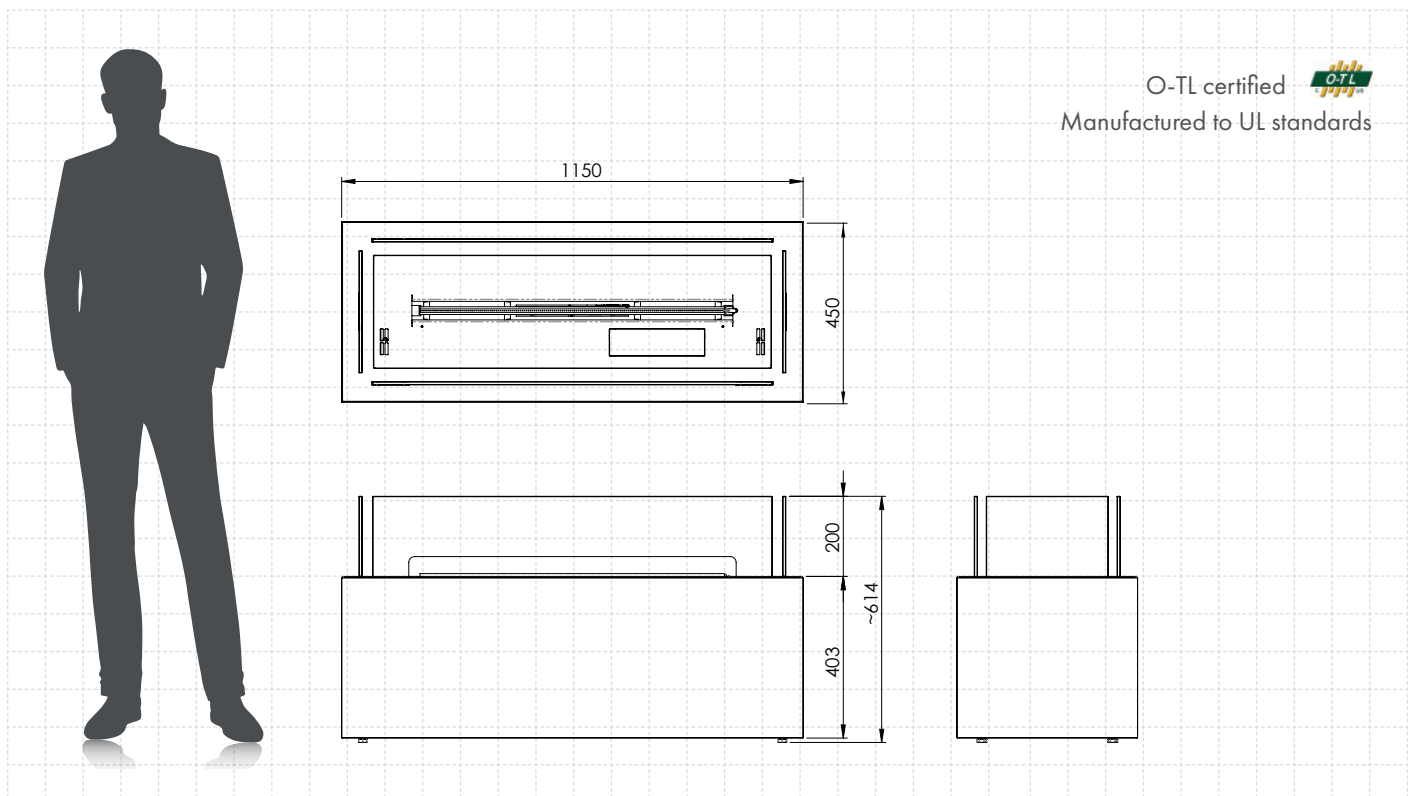
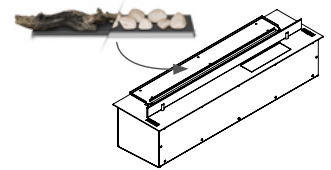

O-TL certified 
Manufactured to UL standards

All product specifications and data are subject to change without notice and are believed to be accurate as of the date hereof. Planika Sp. z o.o., its affiliates, agents, and employees, and all persons acting on its or their behalf (collectively, "Planika Sp. z o.o."), disclaim any and all liability for any errors, inaccuracies or incompleteness contained in any document or in any other disclosure relating to any product. To the maximum extent permitted by applicable law, Planika Sp. z o.o. disclaims any and all liability arising out of the application or use of any product. This document does not expand or otherwise modify Planika Sp. z o.o.'s terms and conditions of purchase, including but not limited to the warranty expressed therein. No license, express or implied, by estoppel or otherwise, to any intellectual property rights is granted by this document or by any conduct of Planika Sp. z o.o.. Customers using or selling Planika Sp. z o.o.'s products not expressly indicated for use in such applications do so entirely at their own risk and agree to fully indemnify Planika Sp. z o.o. for any damages arising or resulting from such use or sale. The images are indicative only.

LAURENT FIREPLACE

WITH FLA3 (990MM) AUTOMATIC ETHANOL BURNER

Net Zero fireplace with BEV Technology®

AUTOMATIC BURNER

The automatic burner with the patented BEV Technology® is the most advanced product in the industry ensuring the cleanest burning process without any smoke, smell or ash. The flame is produced by combusting ethanol vapours and has no direct contact with the liquid fuel.

AUTOMATIC REFILLING SYSTEM

The automatic pump communicates with the device, delivering the necessary amount of fuel. There is no risk of overfilling the tank or spilling the fuel.



SINTERED CERAMIC BOX

The box is made of a highly-renowned Dekton surface by Cosentino – a 12mm thick ultra-compact material made from sintered ceramics, quartz and glass. Utilizing only natural materials, the surface is entirely carbon-neutral and eco-friendly. Its high-performance offers scratch and stain resistance and is known to withstand high temperatures. It has an elegant matte look of Laurent marble, making it an eye-catching decoration in any interior space.

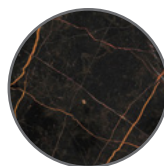

REMOTE CONTROL

Control the fire with the included remote, app on your smartphone or home automation system.

FLAME CONTROL

Have control over the fire and take advantage of the 6-stage flame height

SAFETY SENSORS

- Heat/temperature sensor
- Fuel spillage sensor
- Fuel level sensor

Laurent Fireplace

with FLA3 (990mm) Burner

Fuel tank capacity	5.5 L
Maximum burn time	10 hours
Maximum heat output	7.0 kW
Minimum room cubature	70 m ³
Flame height regulation	6 stages
Weight	81.5 kg
Fuel type	bioethanol 95 - 96,6%
Flue	not required
Air change rate	1 space volume per hour
Power supply	230 V
Finish	Laurent Dekton, black powder coating
Materials	sintered ceramics, steel, galvanized steel, toughened glass
Application	for indoor use only

CONTROL OPTIONS



included



included



optional

'FLA3 NET-ZERO' APP

Control the fire with your smartphone!



OPTIONAL DECORATIVE TRAY

Decorative tray with 2 ceramic logs or white stones installed on the burner, behind the fireline.

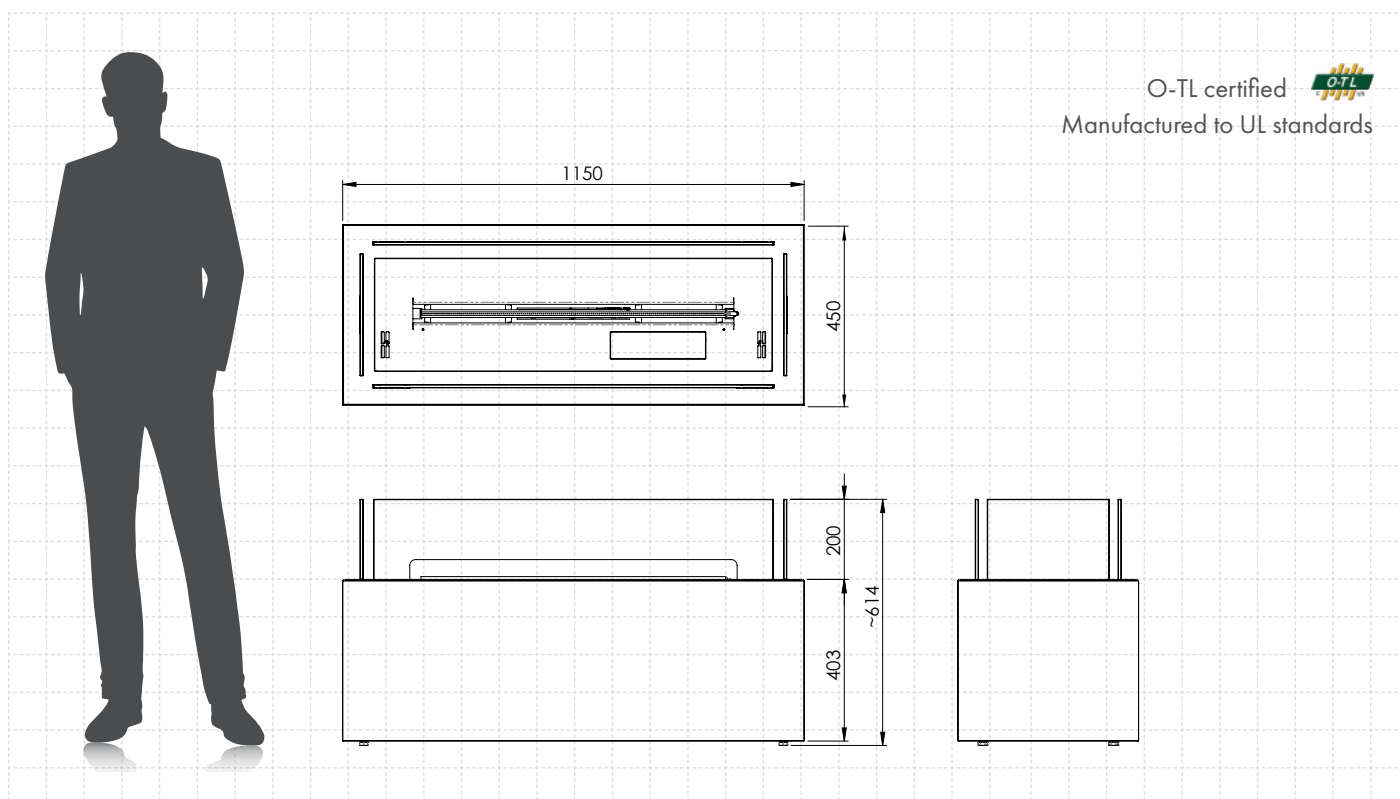
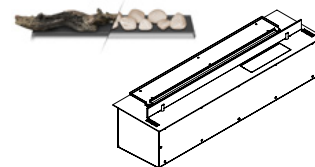

All product specifications and data are subject to change without notice and are believed to be accurate as of the date hereof. Planika Sp. z o.o., its affiliates, agents, and employees, and all persons acting on its or their behalf (collectively, "Planika Sp. z o.o."), disclaim any and all liability for any errors, inaccuracies or incompleteness contained in any document or in any other disclosure relating to any product. To the maximum extent permitted by applicable law, Planika Sp. z o.o. disclaims any and all liability arising out of the application or use of any product. This document does not expand or otherwise modify Planika Sp. z o.o.'s terms and conditions of purchase, including but not limited to the warranty expressed therein. No license, express or implied, by estoppel or otherwise, to any intellectual property rights is granted by this document or by any conduct of Planika Sp. z o.o.. Customers using or selling Planika Sp. z o.o.'s products not expressly indicated for use in such applications do so entirely at their own risk and agree to fully indemnify Planika Sp. z o.o. for any damages arising or resulting from such use or sale. The images are indicative only.

LAURENT FIREPLACE

WITH FLA3+ (990MM) AUTOMATIC ETHANOL BURNER

Net Zero fireplace with BEV Technology®

AUTOMATIC BURNER

The automatic burner with the patented BEV Technology® is the most advanced product in the industry ensuring the cleanest burning process without any smoke, smell or ash. The flame is produced by combusting ethanol vapours and has no direct contact with the liquid fuel.

AUTOMATIC REFILLING SYSTEM

The automatic pump communicates with the device, delivering the necessary amount of fuel. There is no risk of overfilling the tank or spilling the fuel.



SINTERED CERAMIC BOX

The box is made of a highly-renowned Dekton surface by Cosentino – a 12mm thick ultra-compact material made from sintered ceramics, quartz and glass. Utilizing only natural materials, the surface is entirely carbon-neutral and eco-friendly. Its high-performance offers scratch and stain resistance and is known to withstand high temperatures. It has an elegant matte look of Laurent marble, making it an eye-catching decoration in any interior space.

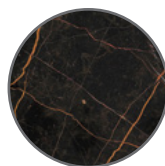

REMOTE CONTROL

Control the fire with the included remote, app on your smartphone or home automation system.

FLAME CONTROL

Have control over the fire and take advantage of the 6-stage flame height

SAFETY SENSORS

- Heat/temperature sensor
- Fuel spillage sensor
- Fuel level sensor

Laurent Fireplace

with FLA3+ (990mm) Burner

Fuel tank capacity	17.2 L
Maximum burn time	31 hours
Maximum heat output	7.0 kW
Minimum room cubature	70 m ³
Flame height regulation	6 stages
Weight	92.5 kg
Fuel type	bioethanol 95 - 96,6%
Flue	not required
Air change rate	1 space volume per hour
Power supply	230 V
Finish	Laurent Dekton, black powder coating
Materials	sintered ceramics, steel, galvanized steel, toughened glass
Application	for indoor use only

CONTROL OPTIONS



included



included



optional

'FLA3 NET-ZERO' APP

Control the fire with your smartphone!



OPTIONAL DECORATIVE TRAY

Decorative tray with 2 ceramic logs or white stones installed on the burner, behind the fireline.

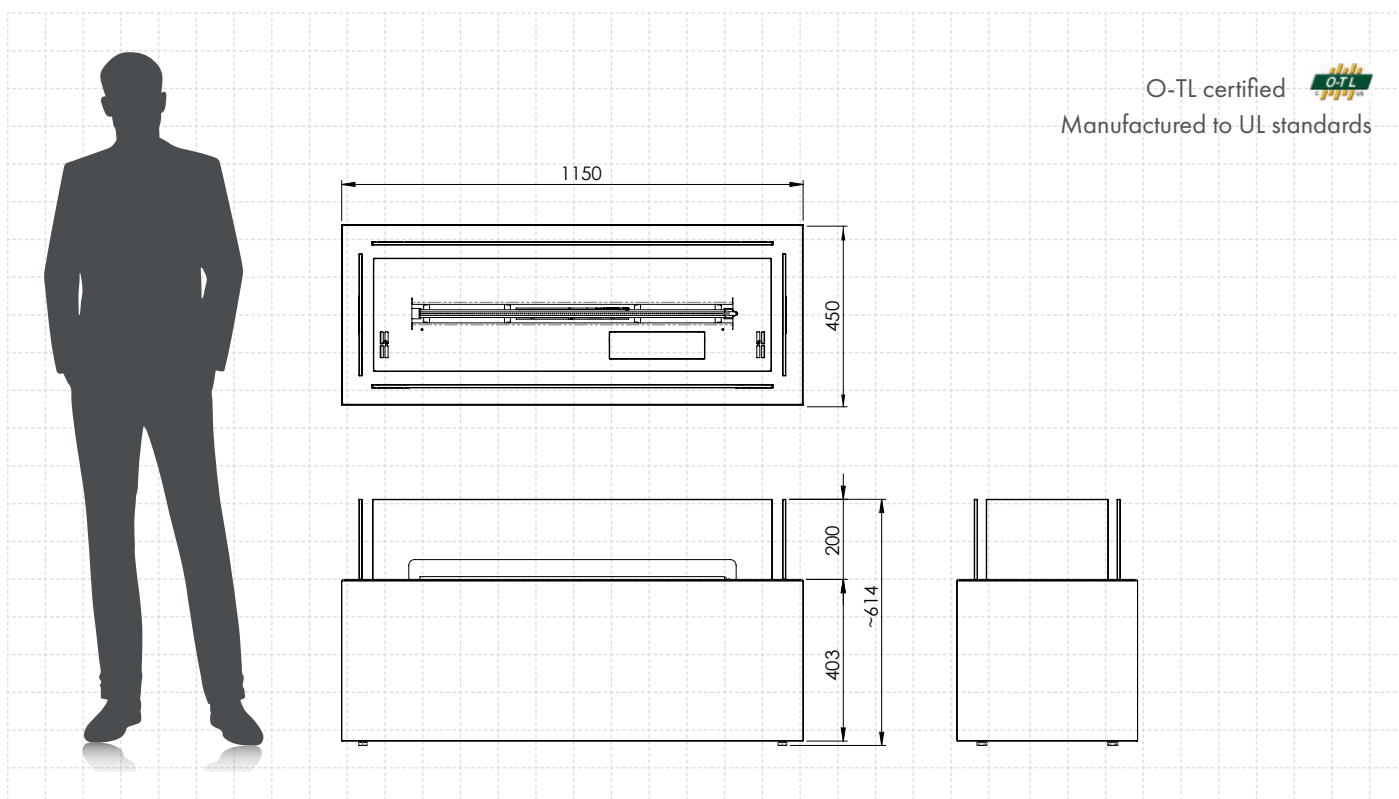
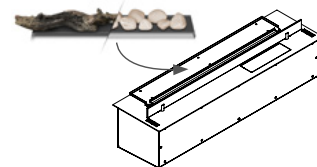

O-TL certified 
Manufactured to UL standards