

Array

1800

Design By Umut Yamac

The Array pendant lamp includes a series of technical filaments that are pulled taut between two rings through which the light rises creating a colour gradient. The cylindrical shape and intimate size make it perfect for small scale spaces.

VIBIA

Model Sheet

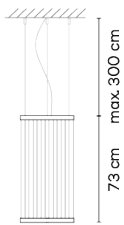

Ø 37 cm

Optional: Extra cable length
Min. quantity, upcharge and extra lead time apply [EN]

Finish

- 24 Beige M1
NCS S 2005-Y50R
- 47 Green L1
NCS S 4005-G80Y
- 37 Terra Red
NCS S 4040-Y70R

LED temperature color 2700 K

Dimming Push; DALI / 1-10V / Casambi

Installation type Remote Micro / Surface Canopy / Built-in S

Materials Upper ring: Aluminum
Bottom ring: Brass
Diffuser: PC- Polycarbonate
Threads: PES FR

Light source 1 x LED STRIP 22W 48V



LED CRI>90 2662 lm 121
2700 K

Driver Constant Voltage 90-305 V V
50-60 Hz HZ

Dimmable IP20 Multi-volt

50-60Hz 1-10V

Application Hanging lamps

Packaging 1 Box
0.12 m x 0.62 m x 0.62 m
Gross weight 7
Net weight 4.8
Vol. 0.0461

Lighting effect

General lighting

Lamp for general lighting that equally distributes the light in all directions.

Photometric Data

Other Applications

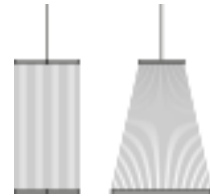

All of our products come with a five-year warranty. Check our legal terms at www.vibia.com/warranty

Vibia Lighting, S.L.U.

Office / Oficina
Progrés 4-6. 08850 Gavà. Barcelona, Spain.

International T +34 934 796 971
Spain / Portugal T +34 934 796 970

customer.service@vibia.com
vibia.com

Array

1805

Design By Umut Yamac



The hanging Array lamp combines a series of fine technical filaments between two rings. Indirect light rises through the cylindrical shape forming a colour gradient.

VIBIA

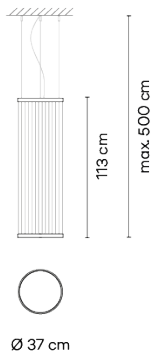
Model Sheet



Optional: Extra cable length
Min. quantity, upcharge and extra lead time apply [EN]

Finish	 37 Terra Red NCS S 4040-Y70R
	 47 Green L1 NCS S 4005-G80Y
	 24 Beige M1 NCS S 2005-Y50R
LED temperature color	2700 K
Dimming	1-10V / Casambi / Push; DALI
Installation type	Surface Canopy / Remote Micro / Built-in S

Materials Upper ring: Aluminum
Bottom ring: Brass
Diffuser: PC- Polycarbonate
Threads: PES FR

Light source 1 x LED STRIP 22W 48V



LED CRI>90 2662 lm 121
2700 K

Driver Constant Voltage 90~305 V V
50~60 Hz HZ



Application Hanging lamps

Packaging 1 Box
0.12 m x 0.62 m x 0.62 m
Gross weight 7,3
Net weight 5,1
Vol. 0.0461

Lighting effect

General lighting

Lamp for general lighting that equally distributes the light in all directions.

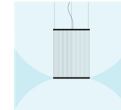

Photometric Data

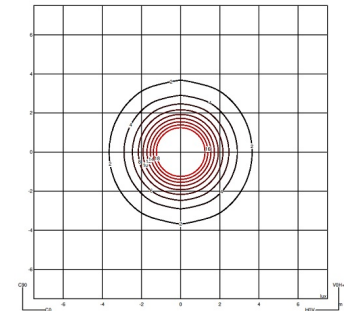
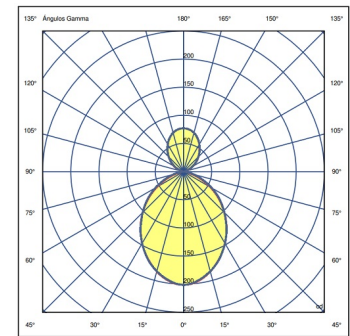

Other Applications

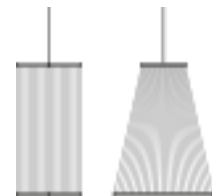

All of our products come with a five-year warranty. Check our legal terms at www.vibia.com/warranty

Vibia Lighting, S.L.U.

Office / Oficina
Progrés 4-6. 08850 Gavà. Barcelona, Spain.

International T +34 934 796 971
Spain / Portugal T +34 934 796 970

customer.service@vibia.com
vibia.com

Array

1810

Design By Umut Yamac



The large scale hanging cylindrical silhouette Array lamp wraps around the space rather than dominating it thanks to its spacious format of filaments that create a transparency through the volume it occupies.

VIBIA

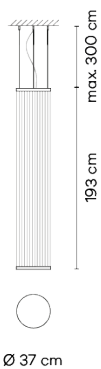
Model Sheet



Optional: Extra cable length
Min. quantity, upcharge and extra lead time apply [EN]

Finish	 37 Terra Red NCS S 4040-Y70R
	 47 Green L1 NCS S 4005-G80Y
	 24 Beige M1 NCS S 2005-Y50R

LED temperature color	2700 K
Dimming	Casambi / Push; DALI / 1-10V
Installation type	Built-in S / Surface Canopy / Remote Micro

Materials	Upper ring: Aluminum Bottom ring: Brass Diffuser: PC- Polycarbonate Threads: PES FR
------------------	--

Light source	1 x LED STRIP 22W 48V
---------------------	-----------------------

LED	CRI>90 2662 lm 121 2700 K
------------	------------------------------

Driver	Constant Voltage 90-305 V V 50-60 Hz HZ
---------------	--



Application	Hanging lamps
--------------------	---------------

Packaging	1 Box 0.12 m x 0.62 m x 0.62 m Gross weighth 7.6 Net weighth 5.4 Vol. 0.0461
------------------	--

Lighting effect

General lighting

Lamp for general lighting that equally distributes the light in all directions.

Photometric Data

Other Applications

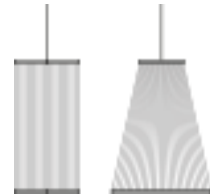

All of our products come with a five-year warranty. Check our legal terms at www.vibia.com/warranty

Vibia Lighting, S.L.U.

Office / Oficina
Progrés 4-6. 08850 Gavà. Barcelona, Spain.

International T +34 934 796 971
Spain / Portugal T +34 934 796 970

customer.service@vibia.com
vibia.com

Array

VIBIA

1815

Design By Umüt Yamac

The hanging Array lamp includes a series of fine technical filaments pulled taut between two rings, where the light rises upwards creating a colour gradient. The cylindrical form and the intimate dimensions make it ideal for small spaces.

Model Sheet

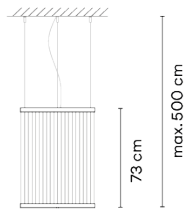

Ø 55 cm

Optional: Extra cable length
Min. quantity, upcharge and extra lead time apply [EN]

Finish

- 47 Green L1
NCS S 4005-G80Y
- 24 Beige M1
NCS S 2005-Y50R
- 37 Terra Red
NCS S 4040-Y70R

LED temperature color 2700 K

Dimming 1-10V / Push; DALI / Casambi

Installation type Built-in S / Remote Micro / Surface Canopy

Materials

- Upper ring: Aluminum
- Bottom ring: Brass
- Diffuser: PC- Polycarbonate
- Threads: PES FR

Light source 1 x LED STRIP 33W 48V



LED CRI>90 3993 lm 121 2700 K

Driver Constant Voltage 90~305 V V 50~60 Hz HZ

Dimmable IP20 Multi-volt

50-60Hz 1-10V

Application Hanging lamps

Packaging

- 1 Box
- 0.12 m x 0.62 m x 0.62 m
- Gross weight 8.4
- Net weight 6.2
- Vol. 0.0461

Lighting effect

General lighting

Lamp for general lighting that equally distributes the light in all directions.

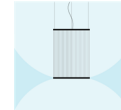

Photometric Data

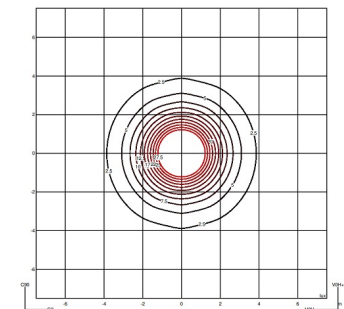
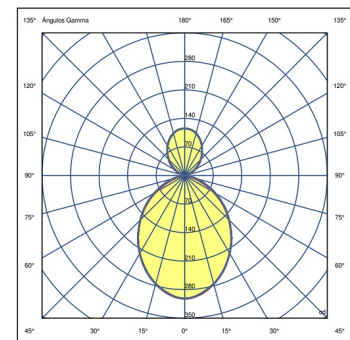

Other Applications

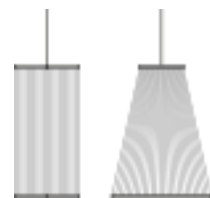

All of our products come with a five-year warranty. Check our legal terms at www.vibia.com/warranty

Vibia Lighting, S.L.U.

Office / Oficina
Progrés 4-6. 08850 Gavà. Barcelona, Spain.

International T +34 934 796 971
Spain / Portugal T +34 934 796 970

customer.service@vibia.com
vibia.com

Array

1820

Design By Umut Yamac

The hanging Array lamp combines a series of fine technical filaments between two rings, The indirect light rises through the cylindrical form creating a colour gradient.

VIBIA

Model Sheet

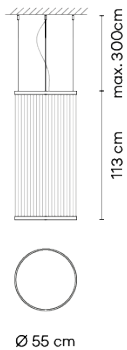

Optional: Extra cable length
Min. quantity, upcharge and extra lead time apply [EN]

Finish	 24 Beige M1 NCS S 2005-Y50R
	 37 Terra Red NCS S 4040-Y70R
	 47 Green L1 NCS S 4005-G80Y

LED temperature color 2700 K

Dimming 1-10V / Casambi / Push; DALI

Installation type Surface Canopy / Built-in S / Remote Micro

Materials Upper ring: Aluminum
Bottom ring: Brass
Diffuser: PC- Polycarbonate
Threads: PES FR

Light source 1 x LED STRIP 33W 48V



LED CRI>90 3993 lm 121
2700 K

Driver Constant Voltage 90~305 V V
50~60 Hz HZ



Application Hanging lamps

Packaging 1 Box
0.12 m x 0.62 m x 0.62 m
Gross weight 8.8
Net weight 6.6
Vol. 0.0461

Lighting effect

General lighting

Lamp for general lighting that equally distributes the light in all directions.

Photometric Data

Other Applications

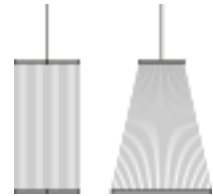

All of our products come with a five-year warranty. Check our legal terms at www.vibia.com/warranty

Vibia Lighting, S.L.U.

Office / Oficina
Progrés 4-6. 08850 Gavà. Barcelona, Spain.

International T +34 934 796 971
Spain / Portugal T +34 934 796 970

customer.service@vibia.com
vibia.com

Array

1825

Design By Umut Yamac

The large-scale cylindrical silhouette hanging Array lamp wraps around the space rather than dominating it thanks to the spacious spread of the filaments creating a more translucent volume. Evoking an ethereal visual sensation.

VIBIA

Model Sheet

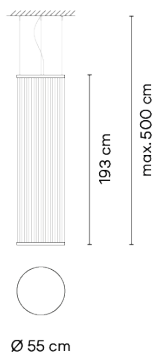

Optional: Extra cable length
Min. quantity, upcharge and extra lead time apply [EN]

Finish

- 24 Beige M1
NCS S 2005-Y50R
- 47 Green L1
NCS S 4005-G80Y
- 37 Terra Red
NCS S 4040-Y70R

LED temperature color 2700 K

Dimming 1-10V / Push; DALI / Casambi

Installation type Surface Canopy / Built-in S / Remote Micro

Materials Upper ring: Aluminum
Bottom ring: Brass
Diffuser: PC- Polycarbonate
Threads: PES FR

Light source 1 x LED STRIP 33W 48V



LED CRI>90 3993 lm 121
2700 K

Driver Constant Voltage 90~305 V V
50~60 Hz HZ

Dimmable IP20 Multi-volt
 50-60Hz 1-10V

Application Hanging lamps

Packaging 1 Box
0.12 m x 0.62 m x 0.62 m
Gross weight 9,2
Net weight 7
Vol. 0.0461

Lighting effect

General lighting

Lamp for general lighting that equally distributes the light in all directions.

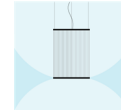

Photometric Data

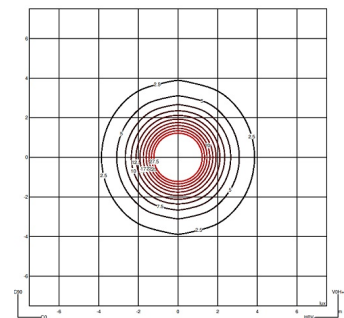
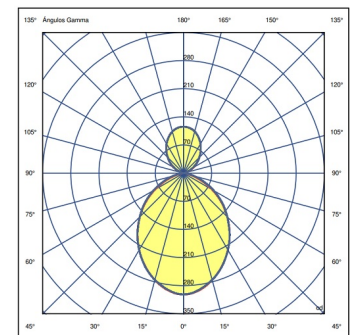

Other Applications

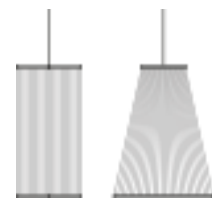

All of our products come with a five-year warranty. Check our legal terms at www.vibia.com/warranty

Vibia Lighting, S.L.U.

Office / Oficina
Progrés 4-6. 08850 Gavà. Barcelona, Spain.

International T +34 934 796 971
Spain / Portugal T +34 934 796 970

customer.service@vibia.com
vibia.com

Array

1830

Design By Umut Yamac

The hanging Array lamp combines a series of fine technical filaments between two rings. The indirect lighting rises through the cylindrical form creating a colour gradient.

VIBIA

Model Sheet

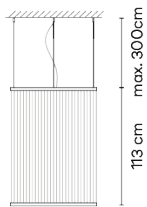

Ø 83 cm

Optional: Extra cable length
Min. quantity, upcharge and extra lead time apply [EN]

Finish	 24 Beige M1 NCS S 2005-Y50R
	 37 Terra Red NCS S 4040-Y70R
	 47 Green L1 NCS S 4005-G80Y

LED temperature color 2700 K

Dimming Push; DALI / 1-10V / Casambi

Installation type Surface Canopy / Built-in S / Remote Micro

Materials Upper ring: Aluminum
Bottom ring: Brass
Diffuser: PC- Polycarbonate
Threads: PES FR



Light source 1 x LED STRIP 50W 48V



LED CRI>90 6050 lm 121
2700 K

Driver Constant Voltage 90~305 V V
50~60 Hz HZ

 Dimmable  IP20  Multi-volt

 50-60Hz  1-10V

Application Hanging lamps

Packaging 1 Box
0.12 m x 0.93 m x 0.93 m
Gross weight 15.6
Net weight 10.1
Vol. 0.1037

Lighting effect

General lighting

Lamp for general lighting that equally distributes the light in all directions.

Photometric Data

Other Applications

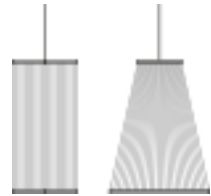

All of our products come with a five-year warranty. Check our legal terms at www.vibia.com/warranty

Vibia Lighting, S.L.U.

Office / Oficina
Progrés 4-6. 08850 Gavà. Barcelona, Spain.

International T +34 934 796 971
Spain / Portugal T +34 934 796 970

customer.service@vibia.com
vibia.com

Array

1835

Design By Umüt Yamac

The large scale hanging cylindrical silhouette Array lamp wraps around the space rather than dominating it thanks to the spacious spread of the filaments creating a translucence through the volume it occupies.

VIBIA

Model Sheet

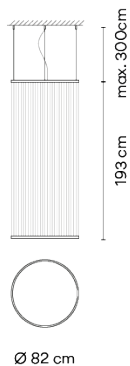

Optional: Extra cable length
Min. quantity, upcharge and extra lead time apply [EN]

Finish	 24 Beige M1 NCS S 2005-Y50R
	 37 Terra Red NCS S 4040-Y70R
	 47 Green L1 NCS S 4005-G80Y

LED temperature color 2700 K

Dimming 1-10V / Push; DALI / Casambi

Installation type Remote Micro / Built-in S / Surface Canopy

Materials Upper ring: Aluminum
Bottom ring: Brass
Diffuser: PC- Polycarbonate
Threads: PES FR



Light source 1 x LED STRIP 50W 48V



LED CRI>90 6050 lm 121
2700 K

Driver Constant Voltage 90-305 V V
50-60 Hz HZ

 **Dimmable**  **IP20**  **Multi-volt**

 **50-60Hz**  **1-10V**

Application Hanging lamps

Packaging 1 Box
0.12 m x 0.93 m x 0.93 m
Gross weight 15
Net weight 9.5
Vol. 0.1037

Lighting effect

General lighting

Lamp for general lighting that equally distributes the light in all directions.

Photometric Data

Other Applications

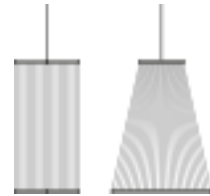

All of our products come with a five-year warranty. Check our legal terms at www.vibia.com/warranty

Vibia Lighting, S.L.U.

Office / Oficina
Progrés 4-6. 08850 Gavà. Barcelona, Spain.

International T +34 934 796 971
Spain / Portugal T +34 934 796 970

customer.service@vibia.com
vibia.com

Array

1840

Design By Umüt Yamac

The hanging Array lamp combines a series of fine technical filaments between two rings. The indirect lighting rises through the cylindrical form creating a colour gradient.

VIBIA

Model Sheet

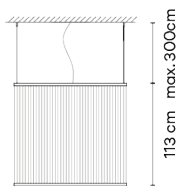

Ø 124 cm

Optional: Extra cable length
Min. quantity, upcharge and extra lead time apply [EN]

Finish	 24 Beige M1 NCS S 2005-Y50R
	 47 Green L1 NCS S 4005-G80Y
	 37 Terra Red NCS S 4040-Y70R

LED temperature color 2700 K

Dimming Casambi / Push; DALI / 1-10V

Installation type Built-in S / Surface Canopy / Remote Micro

Materials Upper ring: Aluminum
Bottom ring: Brass
Diffuser: PC- Polycarbonate
Threads: PES FR



Light source 1 x LED STRIP 76W 48V



LED CRI>90 9196 lm 121
2700 K

Driver Constant Voltage 90-305 V V
50-60 Hz HZ

 Dimmable  IP20  Multi-volt

 50-60Hz  1-10V

Application Hanging lamps

Packaging 1 Box
0.12 m x 1.35 m x 1.35 m
Gross weight 23
Net weight 13
Vol. 0.2187

Lighting effect

General lighting

Lamp for general lighting that equally distributes the light in all directions.

Photometric Data

Other Applications

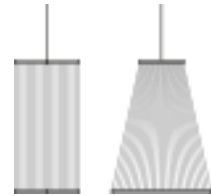

All of our products come with a five-year warranty. Check our legal terms at www.vibia.com/warranty

Vibia Lighting, S.L.U.

Office / Oficina
Progrés 4-6. 08850 Gavà. Barcelona, Spain.

International T +34 934 796 971
Spain / Portugal T +34 934 796 970

customer.service@vibia.com
vibia.com

Array

1845

Design By Umut Yamac

The large-scale cylindrical silhouette hanging Array lamp wraps around the space rather than dominating it thanks to the spacious spread of the filament creating a translucence through the volume it occupies.

VIBIA

Model Sheet

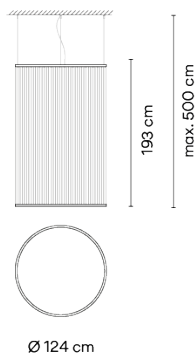

Optional: Extra cable length
Min. quantity, upcharge and extra lead time apply [EN]

Finish

- 37 Terra Red
NCS S 4040-Y70R
- 24 Beige M1
NCS S 2005-Y50R
- 47 Green L1
NCS S 4005-G80Y

LED temperature color 2700 K

Dimming Casambi / 1-10V / Push; DALI

Installation type Remote Micro / Surface Canopy / Built-in S

Materials Upper ring: Aluminum
Bottom ring: Brass
Diffuser: PC- Polycarbonate
Threads: PES FR

Light source 1 x LED STRIP 76W 48V



LED CRI>90 9196 lm 121
2700 K

Driver Constant Voltage 90~305 V V
50~60 Hz HZ

Dimmable IP20 50-60Hz

1-10V

Application Hanging lamps

Packaging 1 Box
0.12 m x 1.35 m x 1.35 m
Gross weight 23.9
Net weight 13.9
Vol. 0.2187

Lighting effect

General lighting

Lamp for general lighting that equally distributes the light in all directions.

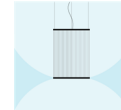

Photometric Data

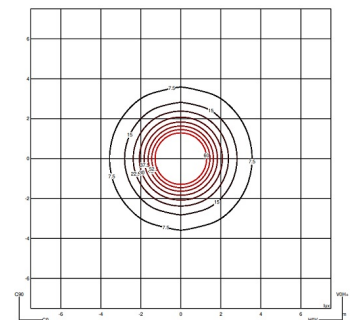
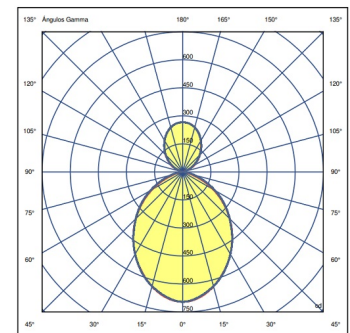

Other Applications

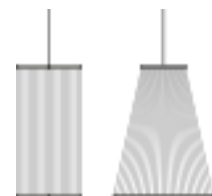

All of our products come with a five-year warranty. Check our legal terms at www.vibia.com/warranty

Vibia Lighting, S.L.U.

Office / Oficina
Progrés 4-6. 08850 Gavà. Barcelona, Spain.

International T +34 934 796 971
Spain / Portugal T +34 934 796 970

customer.service@vibia.com
vibia.com

Array

1850

Design By Umut Yamac

The Array hanging lamp includes a series of technical filaments pulled taut between two rings where the light rises creating a colour gradient. The conical shape and intimate dimensions make it ideal for small spaces.

VIBIA

Model Sheet

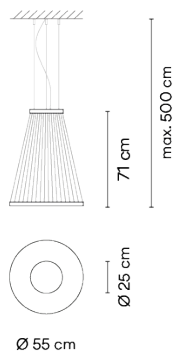

Optional: Extra cable length
Min. quantity, upcharge and extra lead time apply [EN]

Finish

- 37 Terra Red
NCS S 4040-Y70R
- 24 Beige M1
NCS S 2005-Y50R
- 47 Green L1
NCS S 4005-G80Y

LED temperature color 2700 K

Dimming Push; DALI / Casambi / 1-10V

Installation type Built-in S / Surface Canopy / Remote Micro

Materials Upper ring: Aluminum
Bottom ring: Brass
Diffuser: PC- Polycarbonate
Threads: PES FR

Light source 1 x LED STRIP 33W 48V



LED CRI>90 3993 lm 121
2700 K

Driver Constant Voltage 90~305 V V
50~60 Hz HZ

Dimmable IP20 Multi-volt

50-60Hz 1-10V

Application Hanging lamps

Packaging 1 Box
0.12 m x 0.62 m x 0.62 m
Gross weight 7,9
Net weight 5,7
Vol. 0.0461

Lighting effect

General lighting

Lamp for general lighting that equally distributes the light in all directions.



Photometric Data

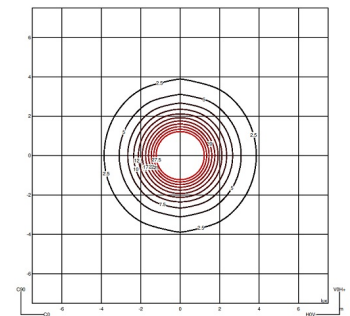
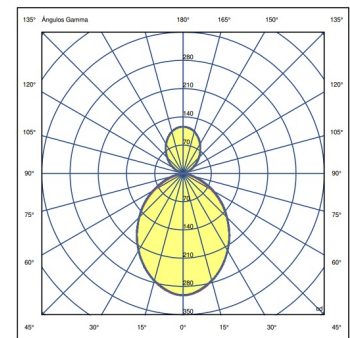

Other Applications

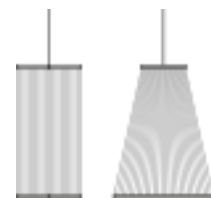

All of our products come with a five-year warranty. Check our legal terms at www.vibia.com/warranty

Vibia Lighting, S.L.U.

Office / Oficina
Progrés 4-6. 08850 Gavà. Barcelona, Spain.

International T +34 934 796 971
Spain / Portugal T +34 934 796 970

customer.service@vibia.com
vibia.com

Array

1855

Design By Umut Yamac

The Array hanging lamp combines a series of fine technical filaments between two rings. The indirect light rises through its conical shape forming a colour gradation.

VIBIA

Model Sheet

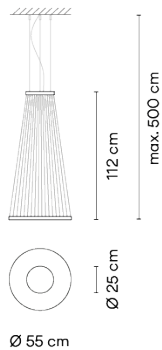

Optional: Extra cable length
Min. quantity, upcharge and extra lead time apply [EN]

Finish

- 47 Green L1
NCS S 4005-G80Y
- 24 Beige M1
NCS S 2005-Y50R
- 37 Terra Red
NCS S 4040-Y70R

LED temperature color 2700 K

Dimming Casambi / 1-10V / Push; DALI

Installation type Surface Canopy / Built-in S / Remote Micro

Materials

- Upper ring: Aluminum
- Bottom ring: Brass
- Diffuser: PC- Polycarbonate
- Threads: PES FR

Light source 1 x LED STRIP 33W 48V



LED CRI>90 3993 lm 121 2700 K

Driver Constant Voltage 90~305 V V
50~60 Hz HZ

Dimmable **IP20** **Multi-volt**

50-60Hz **1-10V**

Application Hanging lamps

Packaging

- 1 Box
- 0.12 m x 0.62 m x 0.62 m
- Gross weight 8.3
- Net weight 6.1
- Vol. 0.0461

Lighting effect

General lighting

Lamp for general lighting that equally distributes the light in all directions.



Photometric Data

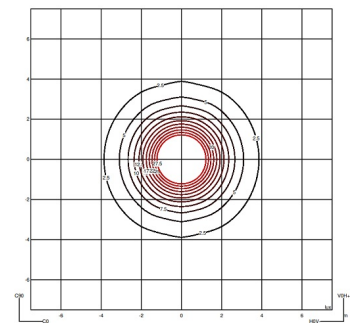
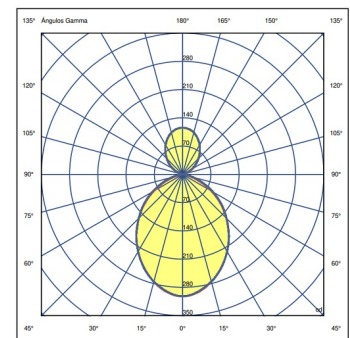

Other Applications

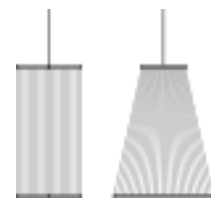

All of our products come with a five-year warranty. Check our legal terms at www.vibia.com/warranty

Vibia Lighting, S.L.U.

Office / Oficina
Progrés 4-6. 08850 Gavà. Barcelona, Spain.

International T +34 934 796 971
Spain / Portugal T +34 934 796 970

customer.service@vibia.com
vibia.com

Array

VIBIA

1860



Design By Umut Yamac

The large-scale conical silhouette hanging Array lamp wraps around the space rather than dominating it thanks to the spacious spread of the filaments creating a translucence through the volume it occupies.

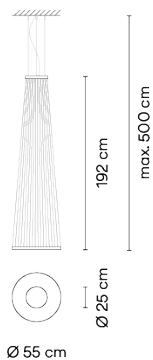
Model Sheet



Optional: Extra cable length
Min. quantity, upcharge and extra lead time apply [EN]

Finish	 37 Terra Red NCS S 4040-Y70R
	 47 Green L1 NCS S 4005-G80Y
	 24 Beige M1 NCS S 2005-Y50R
LED temperature color	2700 K
Dimming	1-10V / Push; DALI / Casambi
Installation type	Built-in S / Surface / Remote Micro

Materials Upper ring: Aluminum
Bottom ring: Brass
Diffuser: PC- Polycarbonate
Threads: PES FR

Light source 1 x LED STRIP 33W 48V



LED CRI>90 3993 lm 121
2700 K

Driver Constant Voltage 90~305 V V
50~60 Hz

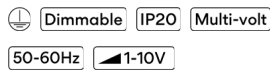

Application Hanging lamps

Packaging 1 Box
0.12 m x 0.62 m x 0.62 m
Gross weight 8.7
Net weight 6.5
Vol. 0.0461

Lighting effect

General lighting

Lamp for general lighting that equally distributes the light in all directions.



Photometric Data

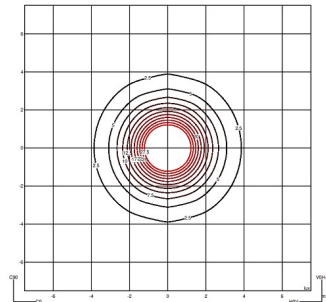
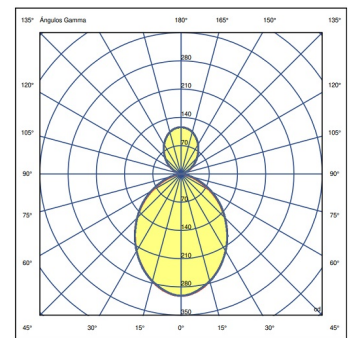

Other Applications

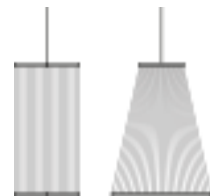

All of our products come with a five-year warranty. Check our legal terms at www.vibia.com/warranty

Vibia Lighting, S.L.U.

Office / Oficina
Progrés 4-6. 08850 Gavà. Barcelona, Spain.

International T +34 934 796 971
Spain / Portugal T +34 934 796 970

customer.service@vibia.com
vibia.com

Array

1865

Design By Umut Yamac

The hanging Array lamp combines a series of fine technical filaments between two rings. The indirect light rises through the conical shape to create a colour gradient.

VIBIA

Model Sheet

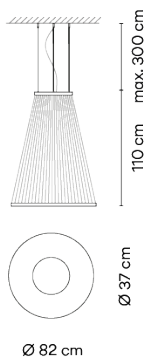

Optional: Extra cable length
Min. quantity, upcharge and extra lead time apply [EN]

Finish	 24 Beige M1 NCS S 2005-Y50R
	 37 Terra Red NCS S 4040-Y70R
	 47 Green L1 NCS S 4005-G80Y

LED temperature color 2700 K

Dimming Push; DALI / Casambi / 1-10V

Installation type Remote Micro / Surface Canopy / Built-in S

Materials Upper ring: Aluminum
Bottom ring: Brass
Diffuser: PC- Polycarbonate
Threads: PES FR



Light source 1 x LED STRIP 50W 48V



LED CRI>90 6050 lm 121
2700 K

Driver Constant Voltage 90-305 V V
50-60 Hz HZ

 Dimmable  IP20  Multi-volt

 50-60Hz  1-10V

Application Hanging lamps

Packaging 1 Box
0.12 m x 0.93 m x 0.93 m
Gross weight 14.3
Net weight 8.8
Vol. 0.1037

Lighting effect

General lighting

Lamp for general lighting that equally distributes the light in all directions.

Photometric Data

Other Applications

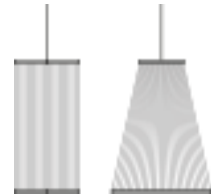

All of our products come with a five-year warranty. Check our legal terms at www.vibia.com/warranty

Vibia Lighting, S.L.U.

Office / Oficina
Progrés 4-6. 08850 Gavà. Barcelona, Spain.

International T +34 934 796 971
Spain / Portugal T +34 934 796 970

customer.service@vibia.com
vibia.com

Array

1870

Design By Umut Yamac

The large-scale conical silhouette hanging Array lamp wraps around the space rather than dominating it thanks to the spacious spread of the filaments creating a translucence through the volume it occupies.

VIBIA

Model Sheet

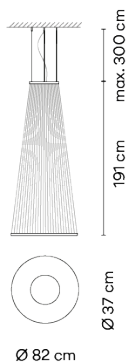

Optional: Extra cable length
Min. quantity, upcharge and extra lead time apply [EN]

Finish

- 37 Terra Red
NCS S 4040-Y70R
- 47 Green L1
NCS S 4005-G80Y
- 24 Beige M1
NCS S 2005-Y50R

LED temperature color 2700 K

Dimming 1-10V / Push; DALI / Casambi

Installation type Built-in S / Remote Micro / Surface Canopy

Materials Upper ring: Aluminum
Bottom ring: Brass
Diffuser: PC- Polycarbonate
Threads: PES FR

Light source 1 x LED STRIP 50W 48V



LED CRI>90 6050 lm 121
2700 K

Driver Constant Voltage 90-305 V V
50-60 Hz HZ



Application Hanging lamps

Packaging 1 Box
0.12 m x 0.93 m x 0.93 m
Gross weight 14.9
Net weight 9.4
Vol. 0.1037

Lighting effect

General lighting

Lamp for general lighting that equally distributes the light in all directions.

Photometric Data

Other Applications

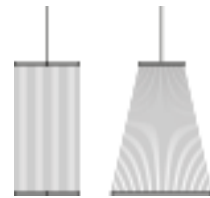

All of our products come with a five-year warranty. Check our legal terms at www.vibia.com/warranty

Vibia Lighting, S.L.U.

Office / Oficina
Progrés 4-6. 08850 Gavà. Barcelona, Spain.

International T +34 934 796 971
Spain / Portugal T +34 934 796 970

customer.service@vibia.com
vibia.com

Array

1875

Design By Umüt Yamac

The hanging Array lamp combines a series of fine technical filaments between two rings. The indirect light rises through its conical shape creating a colour gradient. The combination of shape, texture and luminosity offers an ephemeral visual sensation.

VIBIA

Model Sheet

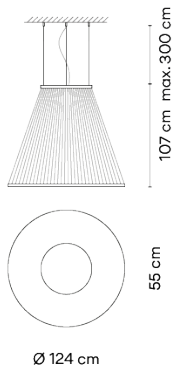

Optional: Extra cable length
Min. quantity, upcharge and extra lead time apply [EN]

Finish	 24 Beige M1 NCS S 2005-Y50R
	 37 Terra Red NCS S 4040-Y70R
	 47 Green L1 NCS S 4005-G80Y

LED temperature color 2700 K

Dimming 1-10V / Casambi / Push; DALI

Installation type Built-in S / Remote Micro / Surface Canopy

Materials Upper ring: Aluminum
Bottom ring: Brass
Diffuser: PC- Polycarbonate
Threads: PES FR



Light source 1 x LED STRIP 76W 48V



LED CRI>90 9196 lm 121
2700 K

Driver Constant Voltage 90-305 V V
50-60 Hz HZ

 Dimmable  IP20  Multi-volt

 50-60Hz  1-10V

Application Hanging lamps

Packaging 1 Box
0.12 m x 1.35 m x 1.35 m
Gross weight 21.9
Net weight 11.9
Vol. 0.2187

Lighting effect

General lighting

Lamp for general lighting that equally distributes the light in all directions.

Photometric Data

Other Applications

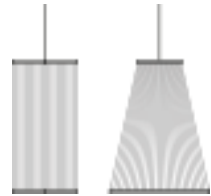

All of our products come with a five-year warranty. Check our legal terms at www.vibia.com/warranty

Vibia Lighting, S.L.U.

Office / Oficina
Progrés 4-6. 08850 Gavà. Barcelona, Spain.

International T +34 934 796 971
Spain / Portugal T +34 934 796 970

customer.service@vibia.com
vibia.com

Array

VIBIA

1880

Design By Umut Yamac

The large-scale conical silhouette hanging Array lamp wraps around the space rather than dominating it thanks to the spacious spread of the filaments creating a translucency through the volume it occupies.

Model Sheet

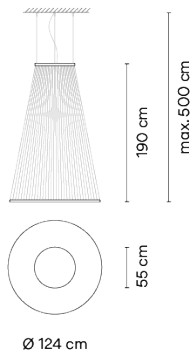

Optional: Extra cable length
Min. quantity, upcharge and extra lead time apply [EN]

Finish

- 47 Green L1
NCS S 4005-G80Y
- 37 Terra Red
NCS S 4040-Y70R
- 24 Beige M1
NCS S 2005-Y50R

LED temperature color 2700 K

Dimming Push; DALI / Casambi / 1-10V

Installation type Surface Canopy / Remote Micro / Built-in S

Materials

- Upper ring: Aluminum
- Bottom ring: Brass
- Diffuser: PC- Polycarbonate
- Threads: PES FR

Light source 1 x LED STRIP 76W 48V



LED CRI>90 9196 lm 121 2700 K

Driver Constant Voltage 90~305 V V
50~60 Hz HZ

Dimmable IP20 Multi-volt

50-60Hz 1-10V

Application Hanging lamps

Packaging

- 1 Box
- 0.12 m x 1.35 m x 1.35 m
- Gross weight 22.8
- Net weight 12.8
- Vol. 0.2187

Lighting effect

General lighting

Lamp for general lighting that equally distributes the light in all directions.



Photometric Data

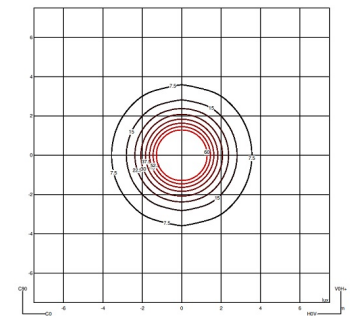
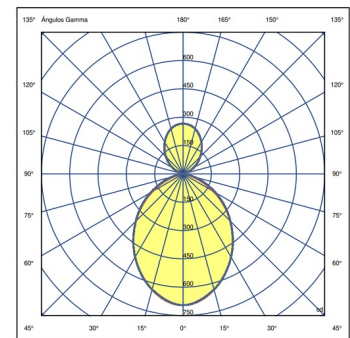

Other Applications

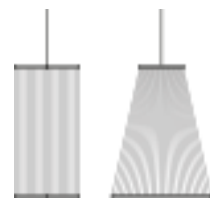

All of our products come with a five-year warranty. Check our legal terms at www.vibia.com/warranty

Vibia Lighting, S.L.U.

Office / Oficina
Progrés 4-6. 08850 Gavà. Barcelona, Spain.

International T +34 934 796 971
Spain / Portugal T +34 934 796 970

customer.service@vibia.com
vibia.com