

DELTA TABLE BASE h:105cm

By Jorge Pensi



Delta collection is made to fit in with exterior or interior contemporary spaces. The injected aluminum base and extracted aluminum column make it ideal for use in the open air, due to the weather-resistant properties of these materials. The folding top and the design of the base enables the tables to be lined up one against the other to save space when they are not in use. The goal of the DELTA chair was to create a timeless product that constantly seeks to strike a balance between realism and surrealism—matter and antimatter, abstraction and emotion. The goal was to maximize emotions while minimizing resources, questioning the common logic of something new.
View online: <https://www.vondom.com/products/66008>

Features

Description

Extruded aluminum tube with cast aluminum base coated with epoxy baked painting. Item suitable for indoor and outdoor use. Table top not included.

Weight

4.26 Kg

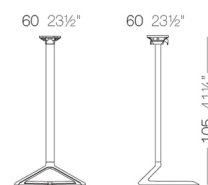

DELTA Pie Mesa 105
DELTA Table Base 105

Finishes

Fixed

Ref. 66008

Powder coated aluminum base with non collapsable attachment made of polyamide and fiber glass

Fixed glass

Ref. 66008V

Powder coated aluminum base with non collapsable aluminum attachment powder coated, made exclusively for our glass tops.

COLLAPSIBLE TOP

Ref. 66008T

Powder coated aluminum base with 90° collapsable attachment made of polyamide and fiber glass

COLOR	BASE FIXED	BASE ABATIBLE	BASE GLASS
BLUE			
MOSTAZA			
WHITE			
BLACK			
BRONZE			
STEEL			
RED			
PISTACHIO			
ECRU			
SAND			

Optional

AVAILABLE TABLE TOPS

AVAILABLE TABLE TOPS

VONDOM

DELTA Collection

assembly instructions fixed / instrucciones de montaje fijo

66006 / 66007 / 66008

- 1 Nut / Tuerca
- 2 Threaded rod / Varilla con rosca
- 3 Base / Base
- 4 Profile / Perfil
- 5 Joining disc / Disco adaptador
- 6 Mounting support / Soporte fijo
- 7 Cap nut / Tuerca ciega
- 8 Screw M6 (x6) / Tornillo M6 (x6)
- 9 Allen wrench / Llave Allen

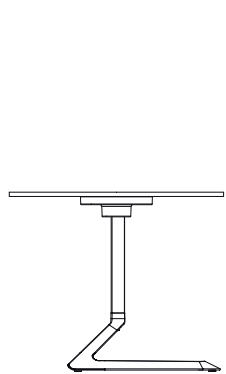
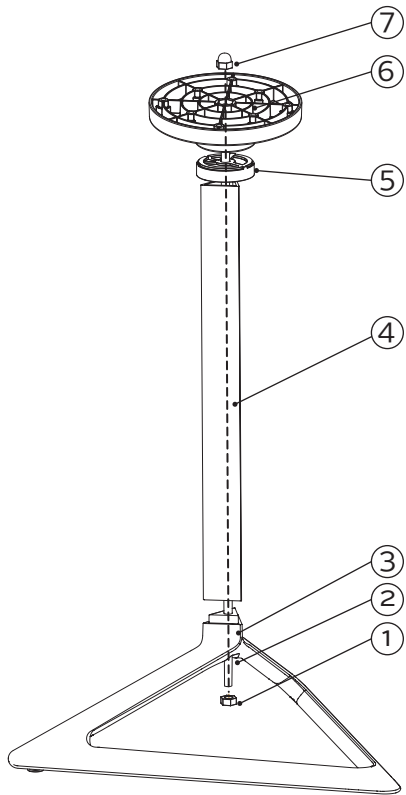

66006

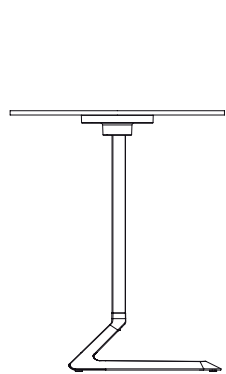

66007

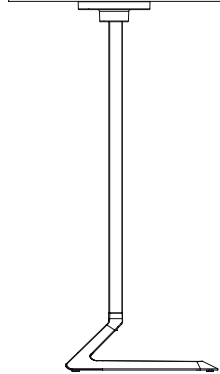

66008

1

Place the cap nut onto the threaded rod and screw the threaded rod through the profile and base until it comes to a complete stop. Next secure the joining disc to the profile. Finally, screw the nut to the base to keep it secure.

Colocar la varilla a la tuerca ciega hasta el fin del recorrido para que quede bloqueada, después el perfil a la base; luego el disco adaptador al perfil; a continuación el soporte fijo y por último apretar la tuerca hasta que quede bloqueada.

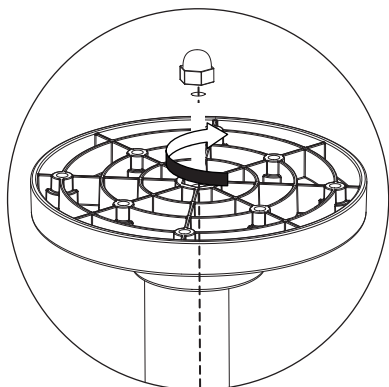

! Screw
Apretar

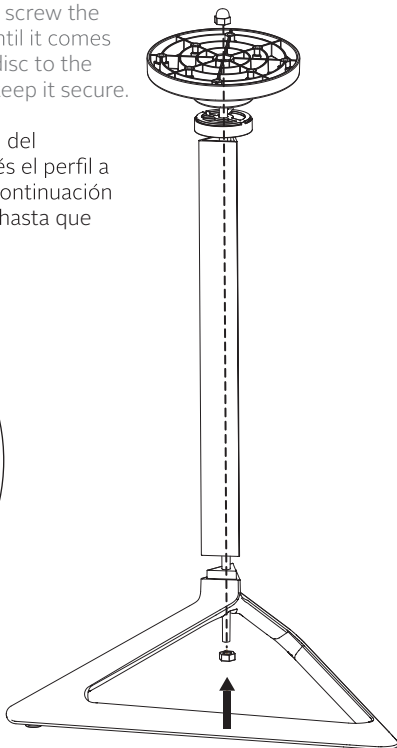

2

Join the table top to the mounting support.
Unir el tablero al sistema fijo.

