



## Voor elke leefruimte de ideale bank

### ROMP

#### Frame

Houten constructie van beuken en mdf.

#### Vering

No-sag veren.

#### Schuim

polyether bedekt met 90 gr dacron.

### ONDERSTEL

1. Geslepen RVS slede of mat zwart, voorzien van rubber voetjes.
2. Notenhouten poten, matgelakt, voorzien van kunststof dop
3. RVS brede poten

### KUSSENS

Er zijn twee verschillende combinaties kussens te verkrijgen in de Axel, een zachte (standaard) variant en een hardere uitvoering.

#### ZACHTE VARIANT ZITKUSSEN

##### Schuim (standaard)

Bestaat uit een combinatie van HR-schuim. Onder een stevig schuim met soortgelijk gewicht van 41 kg/m<sup>3</sup>. Daarboven een zachtere spie die zorgt voor extra comfort en extra valling in de bank. De schuimkern wordt overtrokken met een hoes gevuld met fiber-rolletjes en schuimvlokken (verhouding 70/30%).

##### Rugkussen

Opbouw van een gestikte hoes, verdeeld in vakken. Gevuld met een combinatie van dacronrolletjes en 'memory' schuimvlokken.

## Is the ideal sofa for any living room

### BODY

#### Frame

Wooden construction of beech and mdf.

#### Springs

No-sag springs.

#### Foam

Polyether foam covered with 90 gr dacron.

### FEET

1. Sled base: Ground stainless steel sled or matt black, provided with rubber pads.
2. Legs in walnut, matt provided with plastic pads
3. Wide legs in stainless steel

### CUSHION

There are two different combinations of cushions to obtain in the Axel, a soft cushions (standard) version and a harder version.

#### SEAT CUSHION

##### Foam

Basis of HR foam with a specific gravity of 41 kg/m<sup>3</sup> combined with a thin top layer of HR foam with a specific gravity of 34 kg/m<sup>3</sup> for extra comfort.

##### Padding

Foam flakes and fibre

##### Back cushion

An stitched cover, divided in different pockets. Filled with foam flakes and fibre curls.

## Das ideale Sofa für jedes Wohnzimmer

### KORPUS

#### Frame

Holzkonstruktion von Buchenholz und MDF.

#### Federung

No-sag Federn.

#### Schaum

Polyäther Schaum bedeckt mit 90 gr dacron.

### UNTERGESTELL

1. Kufengestell: Geschliffener Schlitten aus Edelstahl oder matt schwarz, versehen mit Gummifüßen.
2. Füße aus Nussholz, matt lackiert mit Kunststoffgleiter
3. Breite Füße in Edelstahl

### KISSEN

Es gibt zwei verschiedene Kombinationen von Kissen beim Axel, ein weiches Kissen (Standard Version) und eine härtere Version.

#### SITZKISSEN

##### Schaum

Basis aus HR-Schaum mit einem spezifischen Gewicht von 41 kg/m<sup>3</sup> kombiniert mit einer dünnen Oberschicht HR-Schaum mit einem spezifischen Gewicht von 34 kg/m<sup>3</sup> für zusätzlichen Komfort.

##### Decklage

Schaumflocken und Fiberspiralen (Verhältnis 70/30%).

##### Rückenkissen

Ein Bezug, unterteilt in verschiedene Oberflächen. Füllung von Schaumflocken und Fiberspiralen.

## **HARDERE VARIANT ZITKUSSEN**

Van een harder HR schuim met een soort gelijk gewicht van 53 kg/m<sup>3</sup>. De schuimkern wordt overtrokken met een hoes gevuld met fiberrolletjes en schuim vlokken.

## **Rugkussen**

De kern is voorzien van een schuimonderdeel van HR schuim, daaroverheen een gestikte hoes verdeeld in vakken, gevuld met een combinatie van fiberrolletjes en 'memory' schuimvlokken.

## **ARMKUSSEN**

(optioneel)  
Gevuld met veren.

## **AXEL HOOFDSTEUN**

Het hoofdstekussen kan 35 graden naar voren worden gekanteld.

### **Frame**

Metalen strip, ral 9007 structuur gepoedercoated. In de hoofdstek zelf zit een multiplex plaat die d.m.v. scharnieren is verbonden aan het stalen frame.

### **Schuim**

Een kern van zacht HR-schuim met 300 grams dacron.

### **Stoffering**

Afneembare hoes van stof.

## **AXEL PLATEAU**

Het plateau bestaat uit twee metalen platen van 2 mm dik die geheel zijn gestofeerd.

## **HARDER CUSHION**

The base consist of one harder HR-foam with a specific gravity of 53 kg/m<sup>3</sup>. The foamcore is covered with a cover divided in different pockets. Filled with a combination fibrecurts and foam flakes.

## **Back cushion**

Provided with a foam component of HR foam, covered with an stitched cover, divided in different pockets. Filled with latex foam flakes and fibre curls.

## **ARM CUSHION**

(optional)  
Filled with feathers.

## **AXEL HEADREST**

The headrest can be 35 degrees be tilted forward.

### **Frame**

Metal strip, RAL 9007 powder coated structure. In the headrest itself is a plywood plate which is attached into the steel frame.

### **Foam**

Basis of soft HR foam with 300 grams dacron.

### **Upholstrey**

Removable cover in fabric.

## **AXEL PLATEAU**

The plateau consists of two metal sheets of 2 mm thick, which are fully upholstered in leather.

## **HARTE KISSEN**

### **Schaum**

Basis aus einem härteren HR-Schaum mit einem spezifischen Gewicht von 53 kg/m<sup>3</sup>.

### **Decklage**

Schaumflocken und Fiberspiralen.

## **Rückenkissen**

Basis versehen von einem Schaum-komponente aus HR-Schaum, darüber ein Bezug, unterteilt in verschiedene Oberflächen. Füllung von Schaumflocken und Fiberspiralen.

## **ARMKISSEN**

(optional)  
Füllung von Federn.

## **AXEL NACKENSTÜTZE**

Schwenkbar. Die Nackenstütze kann 35 Grad nach vorne geneigt werden.

### **Rahmen**

Metallband, RAL 9007 Struktur pulver-beschichtet. Basis ist eine Sperrholzplatte die mit einem Gelenk verbunden ist mit dem Stahlrahmen.

### **Schaum**

Basis aus HR-Schaum mit 300 g dacron.

### **Polsterung**

Abnehmbarer Bezug aus Stoff.

## **AXEL TABLEAU**

Das Tableau besteht aus zwei Metall-platten 2 mm dick, die in Leder gepolstert sind.

## KUSSENS

De rugkussens van ons model AXEL / AXEL XL hebben een losse vulling. Dit is een vulling van verschillende losse, veerkrachtige en duurzame materialen. De kussens vormen zich gemakkelijk naar uw lichaam en geven daardoor een groot comfort en een natuurlijke nonchalance. Om de vormgeving van uw bank te bewaren is het van belang dat de bank iedere dag na gebruik wordt opgeklopt, zodat de vulling weer luchtig wordt en de vorm wordt hersteld, vergelijkbaar met het hoofdkussen van uw bed. Dit dagelijkse onderhoud komt de levensduur en het comfort van de kussens ten goede en vermindert verkleving van de losse vulling.

## VILTGLIDERS ONDER SLEDE

De glijders onder de sledes worden gemaakt van antislip materialen, zoals rubber of kunststof. In deze materialen zitten stoffen, die onder druk vlekken kunnen veroorzaken op diverse vloeren (kunststof, gietvloeren, pvc, tapijten, betonvloeren, houten vloeren, etc.). Ter voorkoming van een reactie op de vloer, adviseren wij gebruik te maken van bijgeleverde viltglijders.

## CUSHIONS

The back cushions of our model AXEL / AXEL XL have a loose fill. This is a filling consisting of various resilient and durable materials. The Axel / Axel XL cushions easily shape to your body and give great comfort and nonchalance. To preserve the design of your couch it is important to fluff it up every day after use to bring back the airy quality of the stuffing and to recover its shape, just as you would do with the pillows on your bed. The life span and comfort of the pillows greatly benefit from this daily maintenance and you prevent the loose stuffing from clumping together.

## FELT GLIDES UNDER SLED BASE

The glides under the sled bases are made from anti-slip materials such as rubber or plastic. These materials contain substances which can cause stains under pressure on various floors (artificial floors, cast floors, pvc, carpet, concrete floors, hardwood floors, etc.). To prevent a reaction on the floor we recommend using the included felt glides.

## KISSEN

Die Rückenkissen des Modells AXEL / AXEL XL haben eine lose Füllung, die aus elastischen, langlebigen Materialien bestehen. Die Kissen schmiegen sich dem Körper an, sind dadurch komfortabel und geben dem Sofa eine "lässige" Ausstrahlung. Damit das Sofa seine Form behält, ist es wichtig, dass es jeden Tag nach Gebrauch abgeklopft wird, damit die Füllung wieder luftig und die Form wiederhergestellt wird (vergleichbar mit einem Kopfkissen). Diese tägliche Pflege kommt der Lebensdauer und dem Komfort der Kissen zugute und vermeidet ein Verkleben der losen Füllung.

## FILZGLEITER UNTER KUFENGESTELL

Die Gleiter unter die Kufengestelle sind aus rutschfestem Material wie Gummi oder Kunststoff gefertigt. Diese Materialien enthalten Substanzen, die unter Druck auf verschiedenen Böden Flecken verursachen können (Kunststoff, Gussböden, PVC, Teppichböden, Betonböden, Holzböden usw.). Um eine Reaktion auf dem Boden zu vermeiden, empfehlen wir die Verwendung von mitgelieferten Filzgleitern.

# AXEL

Gijs Papavoine 2005

---



# AXEL

Gijs Papavoine 2005

---



---

**SLEDE**  
RVS

---

**SLED BASE**  
Stainless steel

---

**KUFENGESTELL**  
Edelstahl

---



---

**BREDE POOT**  
RVS

---

**WIDE LEGS**  
Stainless steel

---

**WEITE FÜSSE**  
Edelstahl

---



---

**POOT**  
Noten hout

---

**LEGS**  
Walnut

---

**FÜSSE**  
Nussbaum

---

# AXEL

Gijs Papavoine 2005

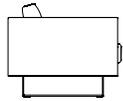

1-Z

**75 cm / 29,5"**  
**59 cm / 23,2"**

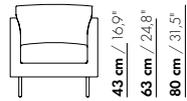

1-Z

**43 cm / 16,9"**  
**63 cm / 24,8"**  
**80 cm / 31,5"**

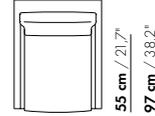

**55 cm / 21,7"**  
**97 cm / 38,2"**

1,5-Z

**103 cm / 40,6"**  
**87 cm / 34,3"**

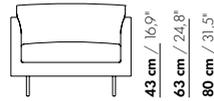

1,5-Z

**43 cm / 16,9"**  
**63 cm / 24,8"**  
**80 cm / 31,5"**



**55 cm / 21,7"**  
**97 cm / 38,2"**

2-Z

**131 cm / 51,6"**  
**115 cm / 45,3"**

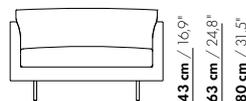

2-Z

**43 cm / 16,9"**  
**63 cm / 24,8"**  
**80 cm / 31,5"**

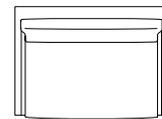

**55 cm / 21,7"**  
**97 cm / 38,2"**

2,5-Z

**159 cm / 62,6"**  
**143 cm / 56,3"**

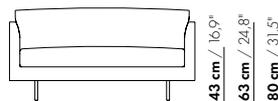

2,5-Z

**43 cm / 16,9"**  
**63 cm / 24,8"**  
**80 cm / 31,5"**

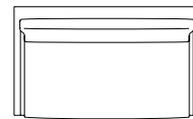

**55 cm / 21,7"**  
**97 cm / 38,2"**

3-Z

**190 cm / 74,8"**  
**174 cm / 68,5"**

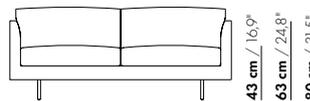

3-Z

**43 cm / 16,9"**  
**63 cm / 24,8"**  
**80 cm / 31,5"**

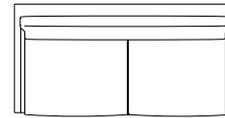

**55 cm / 21,7"**  
**97 cm / 38,2"**

3,5-Z

**218 cm / 85,8"**  
**202 cm / 79,5"**

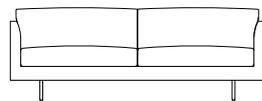

3,5-Z

**43 cm / 16,9"**  
**63 cm / 24,8"**  
**80 cm / 31,5"**

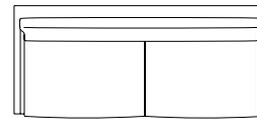

**55 cm / 21,7"**  
**97 cm / 38,2"**

4-Z

**246 cm / 96,9"**  
**230 cm / 90,6"**

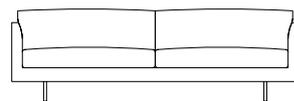

4-Z

**43 cm / 16,9"**  
**63 cm / 24,8"**  
**80 cm / 31,5"**

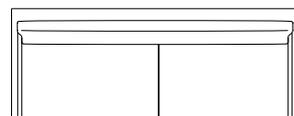

**55 cm / 21,7"**  
**97 cm / 38,2"**

# AXEL

Gijs Papavoine 2005

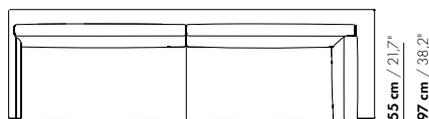
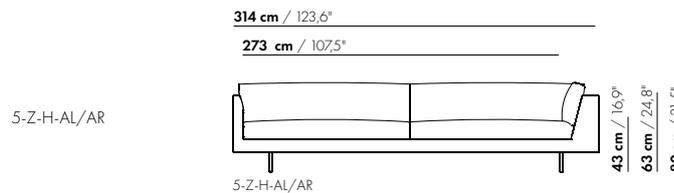
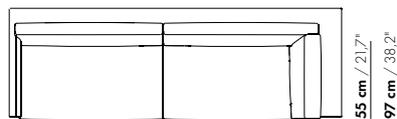
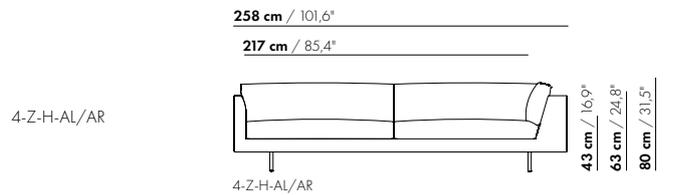
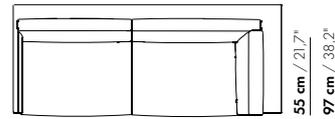
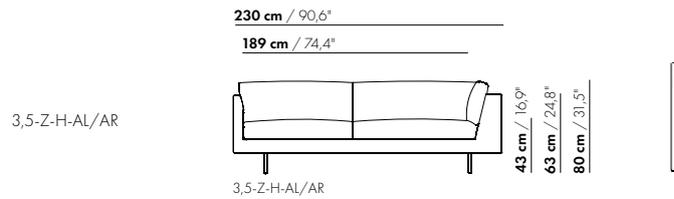
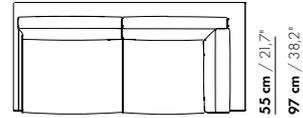
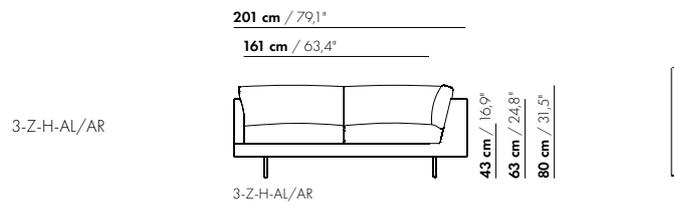
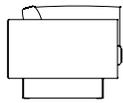
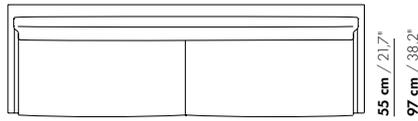
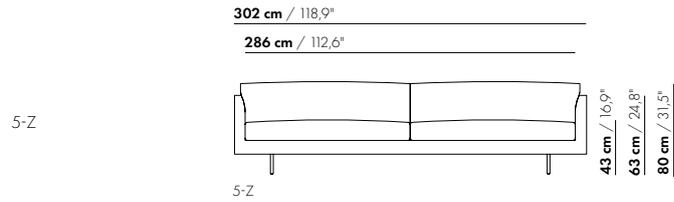

# AXEL

Gijs Papavoine 2005

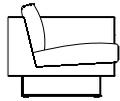

1,5-Z-AL/AR

**95 cm / 37,4"**  
**87 cm / 34,2"**

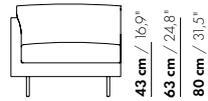

1,5-Z-AL/AR

**43 cm / 16,9"**  
**63 cm / 24,8"**  
**80 cm / 31,5"**

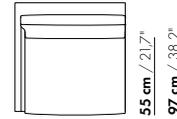

**55 cm / 21,7"**  
**97 cm / 38,2"**

2-Z-AL/AR

**123 cm / 48,4"**  
**115 cm / 45,3"**

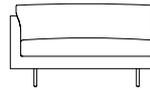

2-Z-AL/AR

**43 cm / 16,9"**  
**63 cm / 24,8"**  
**80 cm / 31,5"**

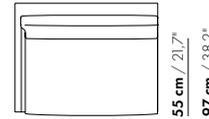

**55 cm / 21,7"**  
**97 cm / 38,2"**

2,5-Z-AL/AR

**151 cm / 59,4"**  
**143 cm / 56,3"**

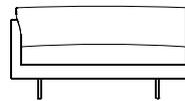

2,5-Z-AL/AR

**43 cm / 16,9"**  
**63 cm / 24,8"**  
**80 cm / 31,5"**

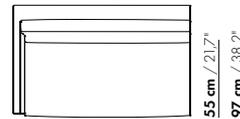

**55 cm / 21,7"**  
**97 cm / 38,2"**

3-Z-AL/AR

**182 cm / 71,7"**  
**173 cm / 68,1"**

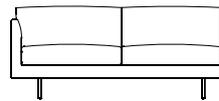

3-Z-AL/AR

**43 cm / 16,9"**  
**63 cm / 24,8"**  
**80 cm / 31,5"**

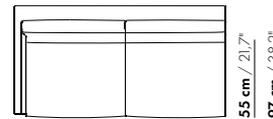

**55 cm / 21,7"**  
**97 cm / 38,2"**

3,5-Z-AL/AR

**210 cm / 82,7"**  
**202 cm / 79,5"**

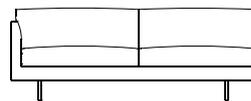

3,5-Z-AL/AR

**43 cm / 16,9"**  
**63 cm / 24,8"**  
**80 cm / 31,5"**

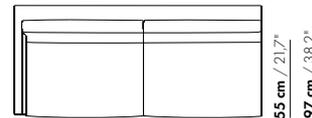

**55 cm / 21,7"**  
**97 cm / 38,2"**

4-Z-AL/AR

**238 cm / 93,7"**  
**230 cm / 90,6"**

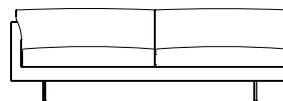

4-Z-AL/AR

**43 cm / 16,9"**  
**63 cm / 24,8"**  
**80 cm / 31,5"**

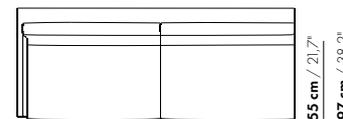

**55 cm / 21,7"**  
**97 cm / 38,2"**

5-Z-AL/AR

**294 cm / 115,7"**  
**286 cm / 112,6"**

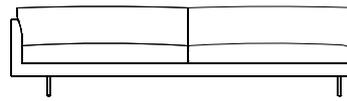

5-Z-AL/AR

**43 cm / 16,9"**  
**63 cm / 24,8"**  
**80 cm / 31,5"**

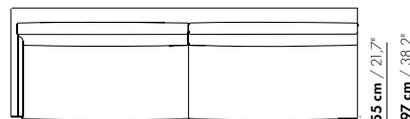

**55 cm / 21,7"**  
**97 cm / 38,2"**



# AXEL

Gijs Papavoine 2005

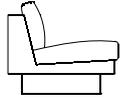

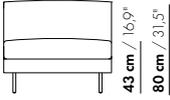
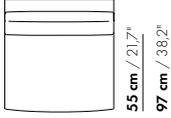
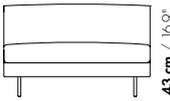
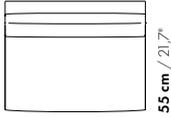
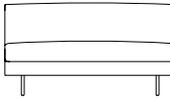
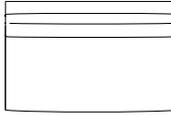
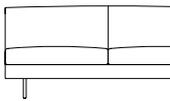
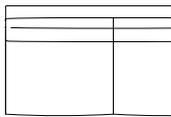
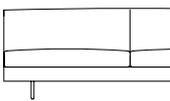
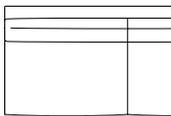
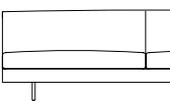
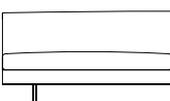
1,5-Z-E	 <p>87 cm / 34,3° 43 cm / 16,9° 80 cm / 31,5°</p>	 <p>55 cm / 21,7° 97 cm / 38,2°</p>
2-Z-E	 <p>115 cm / 45,3° 43 cm / 16,9° 80 cm / 31,5°</p>	 <p>55 cm / 21,7° 97 cm / 38,2°</p>
2,5-Z-E	 <p>143 cm / 56,3° 43 cm / 16,9° 80 cm / 31,5°</p>	 <p>55 cm / 21,7° 97 cm / 38,2°</p>
3-Z-E	 <p>174 cm / 68,5° 43 cm / 16,9° 80 cm / 31,5°</p>	 <p>55 cm / 21,7° 97 cm / 38,2°</p>
3,5-Z-E	 <p>202 cm / 79,5° 43 cm / 16,9° 80 cm / 31,5°</p>	 <p>55 cm / 21,7° 97 cm / 38,2°</p>
4-Z-E	 <p>230 cm / 90,6° 43 cm / 16,9° 80 cm / 31,5°</p>	 <p>55 cm / 21,7° 97 cm / 38,2°</p>
5-Z-E	 <p>286 cm / 112,6° 43 cm / 16,9° 80 cm / 31,5°</p>	 <p>55 cm / 21,7° 97 cm / 38,2°</p>
		 <p>55 cm / 21,7° 97 cm / 38,2°</p>

# AXEL

Gijs Papavoine 2005

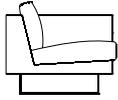

160-CHL-AL/AR

164 cm / 64,6"

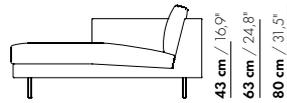

160-CHL-AL/AR

115 cm / 45,3"

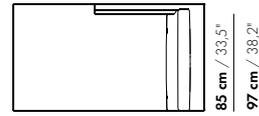

190-CHL-AL/AR

194 cm / 76,4"

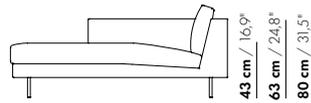

190-CHL-AL/AR

123 cm / 48,4"

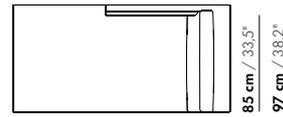

3-Z-D-PL/PR

242 cm / 95,3"

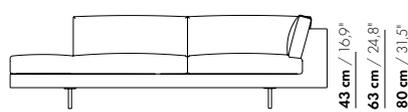

3-Z-D-PL/PR

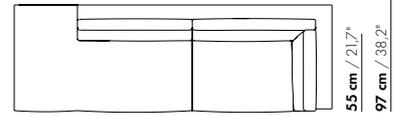

4-Z-D-PL/PR

297 cm / 116,9"

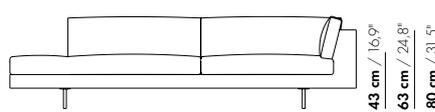

4-Z-D-PL/PR

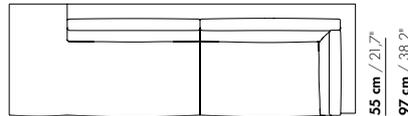

H-45-121-AL/AR

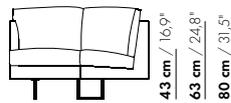

H-45-121-AL/AR

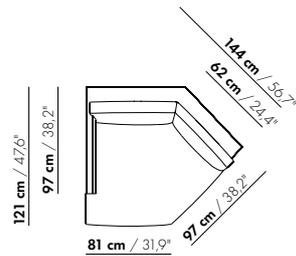

HEADREST

13 cm / 5,1"



66 cm / 26"



20 cm / 7,9"



71 cm / 28"



# AXEL

Gijs Papavoine 2005



P-93x46

93 cm / 36,6"

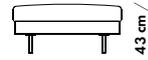

P-93x46



46 cm / 18,1"

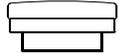

P-93x93

93 cm / 36,6"

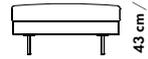

P-93x93



93 cm / 36,6"

274 cm / 107,9"

181 cm / 71,3"

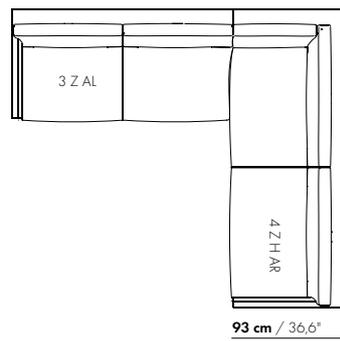

258 cm / 101,6"

93 cm / 36,6"

238 cm / 93,7"

331 cm / 130,3"

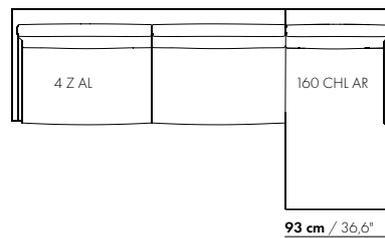

160 cm / 63"

93 cm / 36,6"

325 cm / 128"

181 cm / 71,3"

62 cm / 24,4"

81 cm / 31,9"

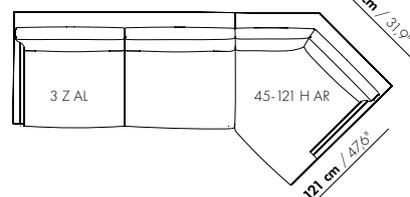

121 cm / 47,6"

# AXEL

Gijs Papavoine 2005

---

STANDARD  
STITCHPATTERN LEATHER

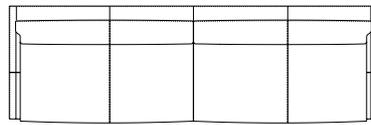
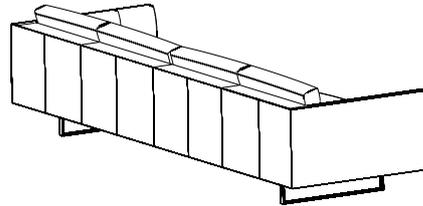
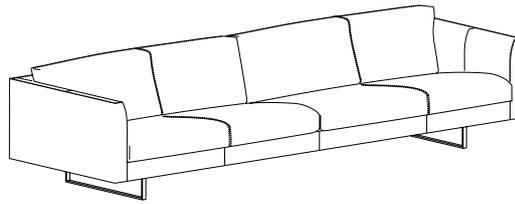

STITCHPATTERN  
EXTRA SEAMS LEATHER  
RANCHO L40

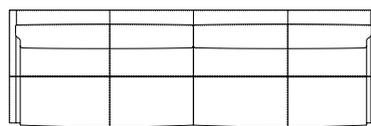
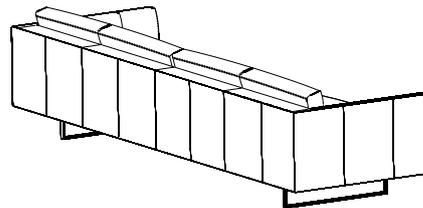
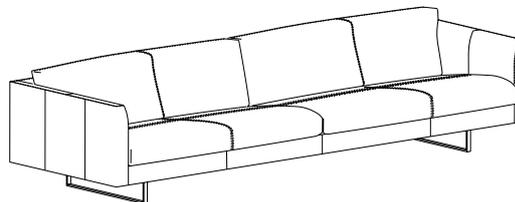

# AXEL

Gijs Papavoine 2005

---

STANDARD  
STITCHPATTERN LEATHER

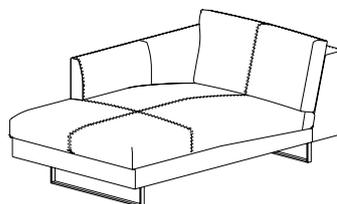
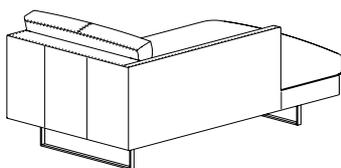

STITCHPATTERN  
EXTRA SEAMS LEATHER  
RANCHO L40

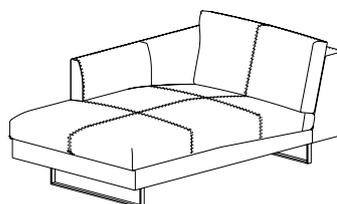
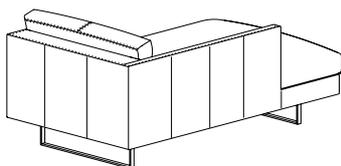

# AXEL XL

Gijs Papavoine 2014



## ROMP

Houten constructie van beuken regels, mdf panelen, etc. No-sag veren Polyether bedekt met 90gr dacron.

## BODY

Wooden construction of beech and mdf.  
No-sag springs  
Polyether foam covered with 90gr dacron.

## KORPUS

Holzkonstruktion von Buchenholz und MDF.  
No-sag Federn  
Polyäther Schaum bedeckt mit 90gr dacron.

## ONDERSTEL

### Slede:

- RVS
- Mat zwart
- eigen keuze  
(selectie RAL-kleuren:  
[www.montis.nl/ral](http://www.montis.nl/ral))

### Aluminium poten:

- hoogglans gepolijst
- hoogglans zwart verchromd

### Houten poten:

- Noten mat gelakt

## FEET

### Slede base:

- RVS
- Matt black.
- custom  
(selection RAL-colours:  
[www.montis.nl/ral](http://www.montis.nl/ral))

### Aluminium legs:

- high-gloss polished
- high-gloss black chrome plated

### Wooden legs:

- Solid walnut matt laquered

## UNTERGESTELL

### Kufengestell:

- Edelstahl
- Matt Schwarz
- eigene Auswahl  
(ausgewählte RAL-Farben:  
[www.montis.nl/ral](http://www.montis.nl/ral))

### Aluminium Füße:

- Hochglanz poliert
- Hochglanz Schwarz verchromt

### Holzfüße:

- Nussbaum matt lackiert

## VILTGLIDERS ONDER SLEDE

De glijders onder de sledes worden gemaakt van antislip materialen, zoals rubber of kunststof. In deze materialen zitten stoffen, die onder druk vlekken kunnen veroorzaken op diverse vloeren (kunststof, gietvloeren, pvc, tapijten, betonvloeren, houten vloeren, etc.). Ter voorkoming van een reactie op de vloer, adviseren wij gebruik te maken van bijgeleverde viltglijders.

## FELT GLIDES UNDER SLED BASE

The glides under the sled bases are made from anti-slip materials such as rubber or plastic. These materials contain substances which can cause stains under pressure on various floors (artificial floors, cast floors, pvc, carpet, concrete floors, hardwood floors, etc.). To prevent a reaction on the floor we recommend using the included felt glides.

## FILZGLEITER UNTER KUFENGESTELL

Die Gleiter unter die Kufengestelle sind aus rutschfestem Material wie Gummi oder Kunststoff gefertigt. Diese Materialien enthalten Substanzen, die unter Druck auf verschiedenen Böden Flecken verursachen können (Kunststoff, Gussböden, PVC, Teppichböden, Betonböden, Holzböden usw.). Um eine Reaktion auf dem Boden zu vermeiden, empfehlen wir die Verwendung von mitgelieferten Filzgleitern.

## KUSSENS

### ZITKUSSEN

De kern bestaat uit een combinatie van HR-schuim. Boven een HR-schuim met een soortelijk gewicht van 38 kg/m<sup>3</sup>. Daaronder een zachtere spie die zorgt voor extra comfort en valling in de bank. De schuimkern wordt overtrokken met een hoes gevuld met fiberrolletjes en 'memory' schuimvlokken. (verhouding 30/70%).

### RUGKUSSEN

Een gestikte hoes, verdeeld in vakken. Gevuld met een combinatie van dacronrolletjes en 'memory'schuim-vlokken.

### ARMKUSSEN

*(optioneel)*  
Gevuld met veren.

## KUSSENS

De rugkussens van ons model AXEL / AXEL XL hebben een losse vulling. Dit is een vulling van verschillende losse, veerkrachtige en duurzame materialen. De kussens vormen zich gemakkelijk naar uw lichaam en geven daardoor een groot comfort en een natuurlijke nonchalance. Om de vormgeving van uw bank te bewaren is het van belang dat de bank iedere dag na gebruik wordt opgeklopt, zodat de vulling weer luchtig wordt en de vorm wordt hersteld, vergelijkbaar met het hoofdkussen van uw bed. Dit dagelijkse onderhoud komt de levensduur en het comfort van de kussens ten goede en vermindert verkleving van de losse vulling.

## CUSHION

### SEAT CUSHION

Basis of HR foam with thin top with a specific gravity of 38 kg/m<sup>3</sup>. Underneath a softer wedge with a specific for extra comfort. foam flakes and fibre curls (ratio 70 / 30%).

### BACK CUSHION

An stitched cover, divided in different pockets. Filled with foam flakes and fibre curls.

### ARM CUSHION

*(optional)*  
Filled with feathers.

## CUSHIONS

The back cushions of our model AXEL / AXEL XL have a loose fill. This is a filling consisting of various resilient and durable materials. The Axel / Axel XL cushions easily shape to your body and give great comfort and nonchalance. To preserve the design of your couch it is important to fluff it up every day after use to bring back the airy quality of the stuffing and to recover its shape, just as you would do with the pillows on your bed. The life span and comfort of the pillows greatly benefit from this daily maintenance and you prevent the loose stuffing from clumping together.

## KISSEN

### SITZKISSEN

Basis aus HR-Schaum mit einem spezifischen Gewicht von 38 kg/m<sup>3</sup> unter einer dünnen Oberschicht HR-Schaum für zusätzlichen Komfort. Schaumflocken und Fiberspiralen (Verhältnis 70 / 30%).

### RÜCKENKISSEN

Ein Bezug, unterteilt in verschiedene Oberflächen. Füllung von Schaumflocken und Fiberspiralen.

### ARMKISSEN

*(optional)*  
Füllung von Federn.

## KISSEN

Die Rückenkissen des Modells AXEL / AXEL XL haben eine lose Füllung, die aus elastischen, langlebigen Materialien bestehen. Die Kissen schmiegen sich dem Körper an, sind dadurch komfortabel und geben dem Sofa eine "lässige" Ausstrahlung. Damit das Sofa seine Form behält, ist es wichtig, dass es jeden Tag nach Gebrauch abgeklopft wird, damit die Füllung wieder luftig und die Form wiederhergestellt wird (vergleichbar mit einem Kopfkissen). Diese tägliche Pflege kommt der Lebensdauer und dem Komfort der Kissen zugute und vermeidet ein Verkleben der losen Füllung.

# AXEL XL

Gijs Papavoine 2014

## AXEL XL TAFEL

### Toepassing

De tafelbladen zijn te gebruiken als dormeusetafel of als poeftafel.

### Romp

Een constructie van gefineerde MDF platen. Fineerrichting in de lengte.

### Uitvoeringen

- Noten gefineerd: mat gelakt
- Eiken gefineerd: blank mat gelakt, wit geolied en zwart carbon gebeitst
- Gespoten in Ral-kleuren (selectie [www.montis.nl/ral](http://www.montis.nl/ral)) of mat zwart

## ELECTRIFICATIE

(optioneel)

De tafelbladen kunnen worden voorzien van een zwart stopcontact en een usb-charger (QC2.0, 2,1A). Standaard gaat het om een stopcontact voor de stekkers E en F (de meeste Europese landen). Optioneel kunnen we ook voor stopcontact G (geschikt voor o.a. UK) en B (USA) leveren.

## QI LADER

(optioneel)

De tafelbladen kunnen worden voorzien van een Qi lader voor het draadloos laden van mobiele telefoons. Deze is weggewerkt in het bovenblad van de tafels. De Qi lader heeft een 10W output en ondersteunt Apple & Samsung Fast Charge. Daarnaast is hij voorzien van een FOD detectie (hij detecteert als er een niet-Qi device of object op de oplader ligt en schakelt zichzelf uit).

## AXEL XL TABLE

### Application

The tabletops can be used as a dormeus table or a pouffe table.

### Body

A construction of veneered MDF boards. Veneer direction lengthwise.

### Finishes

- Walnut veneer: matt lacquered
- Oak veneer: clear matt lacquered, white oiled and black carbon stained
- Sprayed in Ral colour (selectie [www.montis.nl/ral](http://www.montis.nl/ral)) or matt black

## ELECTRICITY SUPPLY

(optional)

The tabletops can be fitted with a black socket and a usb charger (QC2.0, 2.1A). As standard, this is a socket for E and F plugs (most European countries). We can also optionally supply the G (suitable for the UK, among other countries) and B sockets (USA).

## QI LADER

(optional)

The tabletops can be fitted with an Qi charger for wireless charging of mobile phones. This has been housed in the top of the tables. The Qi charger has a 10W output and supports Apple & Samsung Fast Charge. In addition, it has been equipped with FOD detection (it detects when there is a non-Qi device or object on the charger and switches itself off).

## AXEL XL TISCH

### Benutzen

Die Tischplatten können als Dormeus-Tisch oder als Pouffe-Tisch verwendet werden.

### Rumpf

Eine Konstruktion aus furnierten MDF-Platten. Furnierrichtung in Längsrichtung.

### Ausführungen

- Furnier Nussbaum: matt lackiert
- Eichenfurnier: blank matt lackiert, weiß geölt und schwarz karbon gebeitst
- Gespritzt in RAL-Farben. (Auswahl [www.montis.nl/ral](http://www.montis.nl/ral)) oder matt schwarz

## ELEKTRIFIZIERUNG

(optional)

Die Tischplatten können mit einer schwarzen Steckdose und einem usb-Ladegerät (QC2.0, 2.1A) ausgestattet werden. Standardsteckdose für Steckertyp E und F (für die meisten europäischen Länder). Optional auch mit Steckdose G (für u. a. GB) und B (USA) erhältlich.

## QI-LADESTATION

(optional)

Die Tischplatten können mit einem Qi-Ladegerät zum kabellosen Aufladen von Mobiltelefonen ausgestattet werden. Diese befindet sich in der oberen Tischplatte. Die Qi-Ladestation besitzt eine Leistung von 10 W und unterstützt Apple und Samsung Fast Charge. Außerdem besitzt sie eine FOD Erkennung und schaltet sich aus, wenn kein Qi-Gerät oder Objekt auf der Ladestation liegt.



# AXEL XL

Gijs Papavoine 2014

## VERLICHTING

(optioneel)

Alle tafelbladen kunnen worden voorzien van een ingebouwde lamp. Hierbij is er keuze uit 2 verschillende lampen:

### 1) Luceplan - Ascent lamp

- Zwart gelakt
- Led 11w, 2700K  
[www.luceplan.com/products/ascent-table](http://www.luceplan.com/products/ascent-table)

### 2) Zero - Curve through table lamp

- Led 8w
- Uitvoering: wit/glas (white RAL 6017)  
[www.zerolighting.com/curve-through-table-inombo](http://www.zerolighting.com/curve-through-table-inombo)

## LIGHTING

(optional)

All table tops can be fitted with a built-in lamp. You can choose between 2 different lamps:

### 1) Luceplan - Ascent lamp

- Black lacquered
- Led 11w, 2700K  
[www.luceplan.com/products/ascent-table](http://www.luceplan.com/products/ascent-table)

### 2) Zero - Curve through table lamp

- Led 8w
- Version: white/glass (RAL 6017)  
[www.zerolighting.com/curve-through-table-inombo](http://www.zerolighting.com/curve-through-table-inombo)

## BELEUCHTUNG

(optional)

Alle Tischplatten können mit einer eingebauten Lampe ausgestattet werden. Hier gibt es Wahl zwischen 2 verschiedenen Lampen:

### 1) Luceplan - Ascent lamp

- Schwarz lackiert
- Led 11w, 2700K  
[www.luceplan.com/products/ascent-table](http://www.luceplan.com/products/ascent-table)

### 2) Zero - Curve through table lamp

- Led 8w
- Ausführung: weiß/Glass (RAL 6017)  
[www.zerolighting.com/curve-through-table-inombo](http://www.zerolighting.com/curve-through-table-inombo)

## AXEL XL RUGTAFEL

### Romp

Een constructie van gefineerde Multiplex platen. Fineerrichting in de lengte.

### Frame

Metalen frame

### Uitvoeringen

- Noten gefineerd: mat gelakt
- Eiken gefineerd: blank mat gelakt, wit geolied en zwart carbon gebeitst
- Gespoten in Ral-kleuren. (selectie [www.montis.nl/ral](http://www.montis.nl/ral)) of mat zwart

### Plaatsing

De AXEL XL rugtafel kan op alle ruggen van de AXEL XL/AXEL XL-S elementen worden geplaatst.

**Let op:** Als de armtafel langere tijd op één plek over de rug zit geschoven is het mogelijk dat een lichte afdruk in de stof of leer achterblijft.

### Maximaal gewicht

Het tafeltje is geschikt om een gewicht van maximaal 5 kg te kunnen dragen.

## AXEL XL CONSOLE TABLE

### Body

A construction of veneered Multiplex boards. Veneer direction lengthwise.

### Frame

metal frame

### Finishes

- Walnut veneer: matt lacquered
- Oak veneer: clear matt lacquered, white oiled and black carbon stained
- Sprayed in Ral colour (selection [www.montis.nl/ral](http://www.montis.nl/ral)) or matt black

### Placement

Our console table is a welcome addition to any AXEL XL/AXEL XL-S back element, and always a perfect fit.

**Please note:** the console table may leave a slight imprint in the fabric or leather upholstery when mounted in the same place for a long amount of time.

### Weight limit

This table was designed to hold up to 5 kg (or 11 lb.).

## AXEL XL RÜCKENTISCH

### Rumpf

Eine Konstruktion aus furnierten Multiplex-Platten. Furnierichtung in Längsrichtung.

### Rahmen

Metallrahmen

### Ausführungen

- Furnier Nussbaum: matt lackiert
- Eichenfurnier: blank matt lackiert, weiß geölt und schwarz karbon gebeitst
- Gespritzt in RAL-Farben. (Auswahl [www.montis.nl/ral](http://www.montis.nl/ral)) oder matt schwarz

### Platzierung

Der AXEL XL Rückentisch kann auf alle Rückseiten der Elemente AXEL XL und AXEL XL-S montiert werden.

**Hinweis:** Wenn der Rückentisch längere Zeit an einer Stelle aufgelegt hat, kann es zu einem leichten Abdruck im Stoff oder Leder kommen.

### Maximales Gewicht

Das Tischchen ist für ein maximales Gewicht von 5 kg geeignet.

# AXEL XL

Gijs Papavoine 2014

---



# AXEL XL

Gijs Papavoine 2014



# AXEL XL

Gijs Papavoine 2014



# AXEL XL

Gijs Papavoine 2014

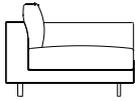

100-AL/AR

109 cm / 42,9"

100 cm / 39,4"

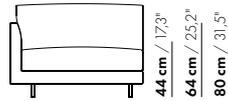

100-AL/AR

124 cm / 48,8"

115 cm / 45,3"

115-AL/AR

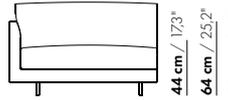

115-AL/AR

139 cm / 54,7"

130 cm / 51,2"

130-AL/AR

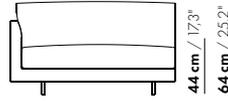

130-AL/AR

184 cm / 72,4"

175 cm / 68,9"

175-AL/AR



175-AL/AR

209 cm / 82,3"

200 cm / 78,7"

200-AL/AR



200-AL/AR

239 cm / 94,1"

230 cm / 90,6"

230-AL/AR



230-AL/AR

269 cm / 105,9"

260 cm / 102,4"

260-AL/AR

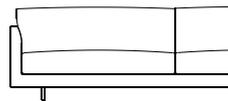

260-AL/AR

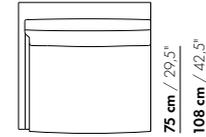
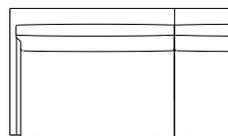

75 cm / 29,5"  
108 cm / 42,5"

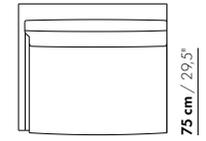

75 cm / 29,5"  
108 cm / 42,5"

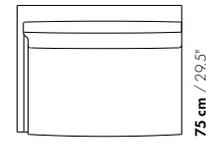

75 cm / 29,5"  
108 cm / 42,5"

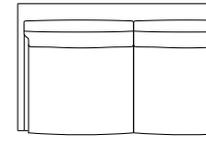

75 cm / 29,5"  
108 cm / 42,5"

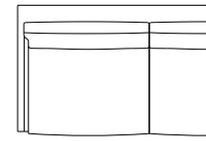

75 cm / 29,5"  
108 cm / 42,5"

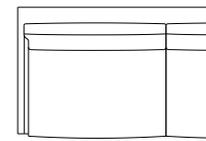

75 cm / 29,5"  
108 cm / 42,5"

# AXEL XL

Gijs Papavoine 2014

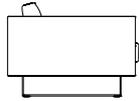

100

118 cm / 46,5"

101 cm / 39,8"

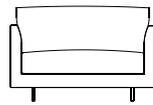

100

44 cm / 17,3"  
64 cm / 25,2"  
80 cm / 31,5"

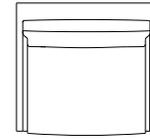

75 cm / 29,5"  
108 cm / 42,5"

175

193 cm / 76"

175 cm / 68,9"

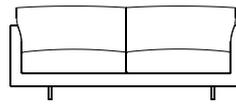

175

44 cm / 17,3"  
64 cm / 25,2"  
80 cm / 31,5"

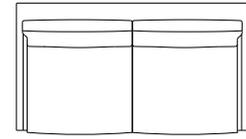

75 cm / 29,5"  
108 cm / 42,5"

200

218 cm / 85,8"

200 cm / 78,7"

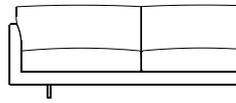

200

44 cm / 17,3"  
64 cm / 25,2"  
80 cm / 31,5"

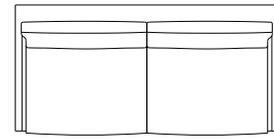

75 cm / 29,5"  
108 cm / 42,5"

230

248 cm / 97,6"

230 cm / 90,6"

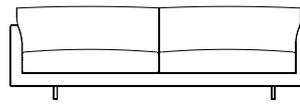

230

44 cm / 17,3"  
64 cm / 25,2"  
80 cm / 31,5"

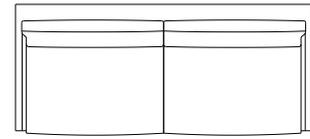

75 cm / 29,5"  
108 cm / 42,5"

260

278 cm / 109,4"

260 cm / 102,4"

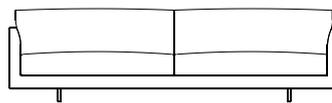

260

44 cm / 17,3"  
64 cm / 25,2"  
80 cm / 31,5"

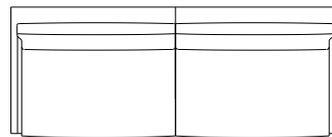

75 cm / 29,5"  
108 cm / 42,5"

# AXEL XL

Gijs Papavoine 2014

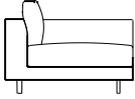

100-B-AL/AR

118 cm / 46,5"  
100 cm / 39,4"



100-B-AL/AR

133 cm / 52,4"  
115 cm / 45,3"

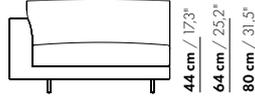

115-B-AL/AR

115-B-AL/AR

148 cm / 58,3"  
130 cm / 51,2"

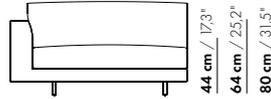

130-B-AL/AR

130-B-AL/AR

193 cm / 76"  
175 cm / 68,9"

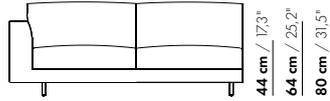

175-B-AL/AR

175-B-AL/AR

218 cm / 85,8"  
200 cm / 78,7"



200-B-AL/AR

200-B-AL/AR

248 cm / 97,6"  
230 cm / 90,6"



230-B-AL/AR

230-B-AL/AR

278 cm / 109,4"  
260 cm / 102,4"

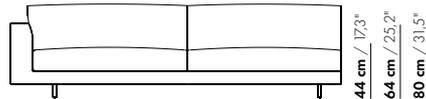

260-B-AL/AR

260-B-AL/AR

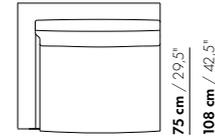
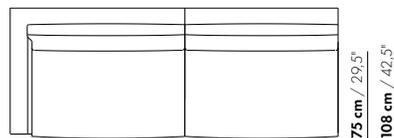

75 cm / 29,5"  
108 cm / 42,5"

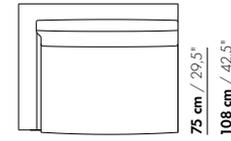

75 cm / 29,5"  
108 cm / 42,5"

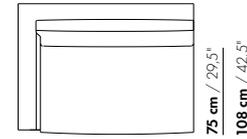

75 cm / 29,5"  
108 cm / 42,5"

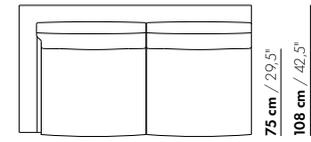

75 cm / 29,5"  
108 cm / 42,5"

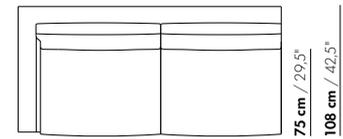

75 cm / 29,5"  
108 cm / 42,5"

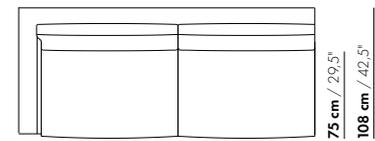

75 cm / 29,5"  
108 cm / 42,5"

# AXEL XL

Gijs Papavoine 2014



175-B

211 cm / 83,1"

175 cm / 68,9"

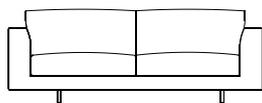

175-B

44 cm / 17,3"  
64 cm / 25,2"  
80 cm / 31,5"

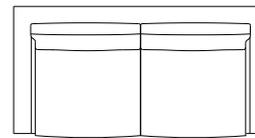

75 cm / 29,5"  
108 cm / 42,5"

200-B

236 cm / 92,1"

200 cm / 79,5"

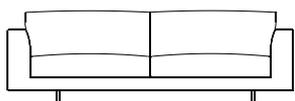

200-B

44 cm / 17,3"  
64 cm / 25,2"  
80 cm / 31,5"

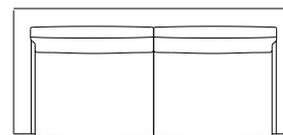

75 cm / 29,5"  
108 cm / 42,5"

230-B

266 cm / 104,7"

230 cm / 90,6"

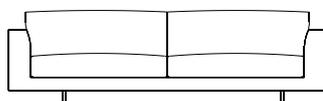

230-B

44 cm / 17,3"  
64 cm / 25,2"  
80 cm / 31,5"

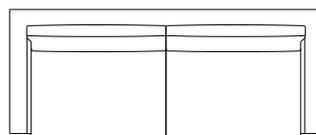

75 cm / 29,5"  
108 cm / 42,5"

260-B

296 cm / 116,5"

260 cm / 102,4"

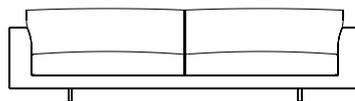

260-B

44 cm / 17,3"  
64 cm / 25,2"  
80 cm / 31,5"

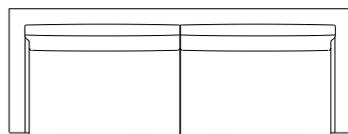

75 cm / 29,5"  
108 cm / 42,5"



# AXEL XL

Gijs Papavoine 2014



100-E

100 cm / 39,4"

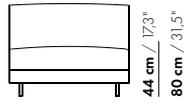

100-E

44 cm / 17,3"  
80 cm / 31,5"

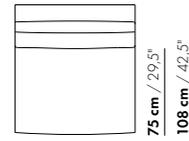

75 cm / 29,5"  
108 cm / 42,5"

115-E

115 cm / 45,3"

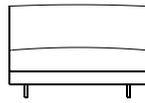

115-E

44 cm / 17,3"  
80 cm / 31,5"

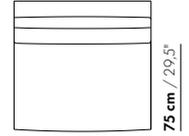

75 cm / 29,5"  
108 cm / 42,5"

130-E

130 cm / 51,2"

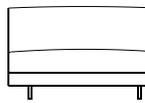

130-E

44 cm / 17,3"  
80 cm / 31,5"

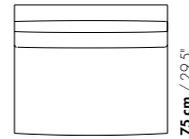

75 cm / 29,5"  
108 cm / 42,5"

175-E

175 cm / 68,9"

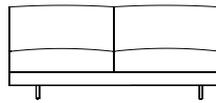

175-E

44 cm / 17,3"  
80 cm / 31,5"

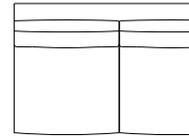

75 cm / 29,5"  
108 cm / 42,5"

200-E

200 cm / 78,7"

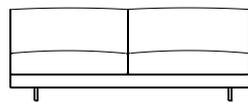

200-E

44 cm / 17,3"  
80 cm / 31,5"

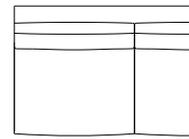

75 cm / 29,5"  
108 cm / 42,5"

230-E

230 cm / 90,6"

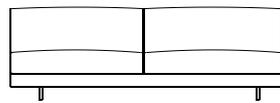

230-E

44 cm / 17,3"  
80 cm / 31,5"

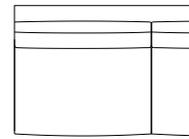

75 cm / 29,5"  
108 cm / 42,5"

260-E

260 cm / 102,4"

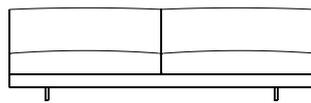

260-E

44 cm / 17,3"  
80 cm / 31,5"

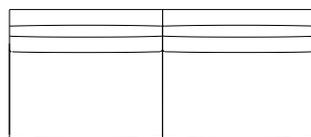

75 cm / 29,5"  
108 cm / 42,5"

# AXEL XL

Gijs Papavoine 2014

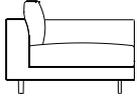

200-H-AL/AR

227 cm / 89,4"

176 cm / 69,3"

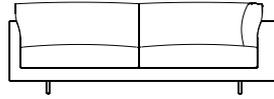

200-H-AL/AR

44 cm / 17,3"

64 cm / 25,2"

80 cm / 31,5"

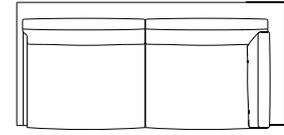

75 cm / 29,5"

108 cm / 42,5"

230-H-AL/AR

257 cm / 101,2"

206 cm / 81,1"



230-H-AL/AR

44 cm / 17,3"

64 cm / 25,2"

80 cm / 31,5"

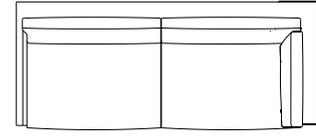

75 cm / 29,5"

108 cm / 42,5"

260-H-AL/AR

287 cm / 113"

236 cm / 92,9"

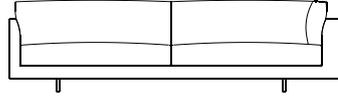

260-H-AL/AR

44 cm / 17,3"

64 cm / 25,2"

80 cm / 31,5"

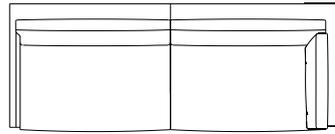

75 cm / 29,5"

108 cm / 42,5"

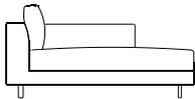

CHL-100-AL/AR

109 cm / 42,9"

100 cm / 39,4"

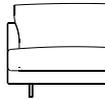

CHL-100-AL/AR

44 cm / 17,3"

64 cm / 25,2"

80 cm / 31,5"

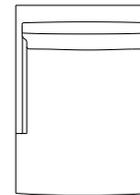

106 cm / 41,7"

157 cm / 61,8"

112 cm / 44,1"

CHL-130-AL/AR

139 cm / 54,7"

130 cm / 51,2"

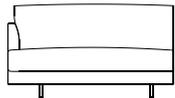

CHL-130-AL/AR

44 cm / 17,3"

64 cm / 25,2"

80 cm / 31,5"

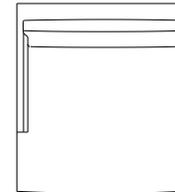

106 cm / 41,7"

157 cm / 61,8"

112 cm / 44,1"

# AXEL XL

Gijs Papavoine 2014

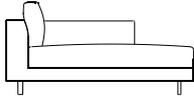

CHL-100-B-AL/AR

**118 cm / 46,5"**  
**100 cm / 39,4"**

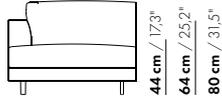

CHL-100-B-AL/AR

**44 cm / 17,3"**  
**64 cm / 25,2"**  
**80 cm / 31,5"**

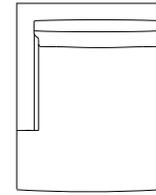

**106 cm / 41,7"**  
**157 cm / 61,8"**  
**112 cm / 44,1"**



CHL-130-B-AL/AR

**148 cm / 58,3"**  
**130 cm / 51,2"**

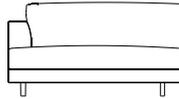

CHL-130-B-AL/AR

**44 cm / 17,3"**  
**64 cm / 25,2"**  
**80 cm / 31,5"**

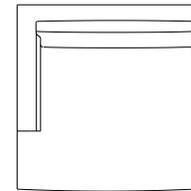

**106 cm / 41,7"**  
**157 cm / 61,8"**  
**112 cm / 44,1"**

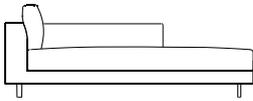

CHL-100X190-AL/AR

**109 cm / 42,9"**  
**100 cm / 39,4"**

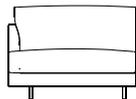

CHL-100X190-AL/AR

**44 cm / 17,3"**  
**64 cm / 25,2"**  
**80 cm / 31,5"**

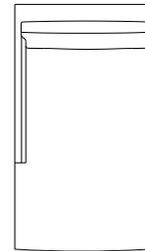

**128 cm / 50,4"**  
**190 cm / 74,8"**  
**139 cm / 54,7"**



CHL-100X190-B-AL/AR

**118 cm / 46,5"**  
**100 cm / 39,4"**

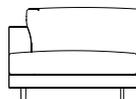

CHL-100X190-B-AL/AR

**44 cm / 17,3"**  
**64 cm / 25,2"**  
**80 cm / 31,5"**

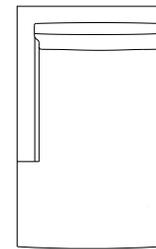

**128 cm / 50,4"**  
**190 cm / 74,8"**  
**139 cm / 54,7"**

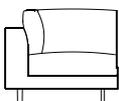

H-106x93

**106 cm / 41,7"**  
**75 cm / 29,5"**

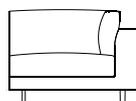

H-106x93

**44 cm / 17,3"**  
**64 cm / 25,2"**  
**80 cm / 31,5"**

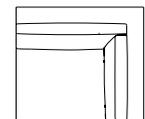

**63 cm / 24,8"**  
**93 cm / 36,6"**



H-93x106

**93 cm / 36,6"**  
**63 cm / 24,8"**

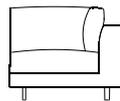

H-93x106

**44 cm / 17,3"**  
**64 cm / 25,2"**  
**80 cm / 31,5"**

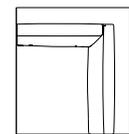

**75 cm / 29,5"**  
**106 cm / 41,7"**

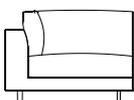

H-106x106

**106 cm / 41,7"**  
**75 cm / 29,5"**

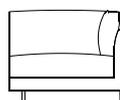

H-106x106

**44 cm / 17,3"**  
**64 cm / 25,2"**  
**80 cm / 31,5"**

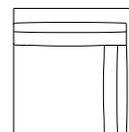

**75 cm / 29,5"**  
**106 cm / 41,7"**

# AXEL XL

Gijs Papavoine 2014

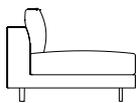

175-D-ZA-PL/PR

247 cm / 97,2"  
175 cm / 68,9" 72 cm / 28,3"

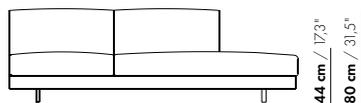

175-D-ZA-PL/PR

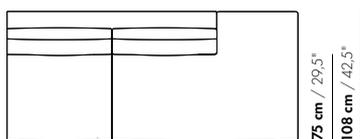

200-D-ZA-PL/PR

272 cm / 107,1"  
200 cm / 78,7" 72 cm / 28,3"



200-D-ZA-PL/PR

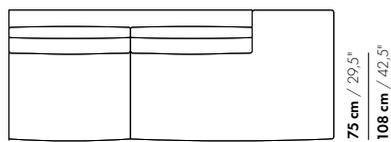

230-D-ZA-PL/PR

302 cm / 118,9"  
230 cm / 90,6" 72 cm / 28,3"

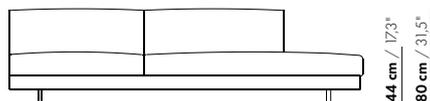

230-D-ZA-PL/PR

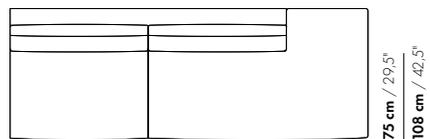

260-D-ZA-PL/PR

332 cm / 130,7"  
260 cm / 102,4" 72 cm / 28,3"

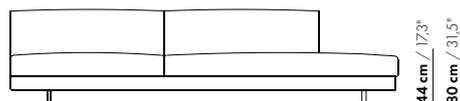

260-D-ZA-PL/PR

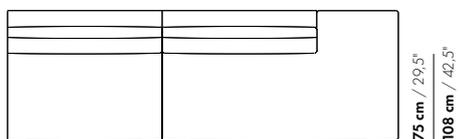

# AXEL XL

Gijs Papavoine 2014

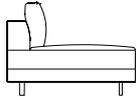

175-D-ZA-TL/TR

243 cm / 95,7"  
175 cm / 68,9" 68 cm / 26,8"

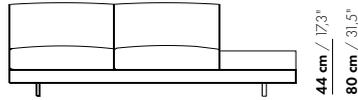

175-D-ZA-TL/TR

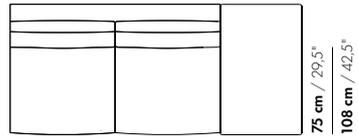

200-D-ZA-TL/TR

268 cm / 105,5"  
200 cm / 78,7" 68 cm / 26,8"

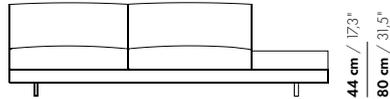

200-D-ZA-TL/TR

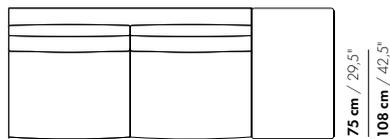

230-D-ZA-TL/TR

298 cm / 117,3"  
230 cm / 90,6" 68 cm / 26,8"

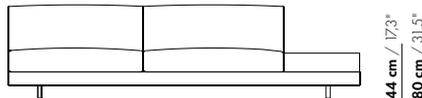

230-D-ZA-TL/TR

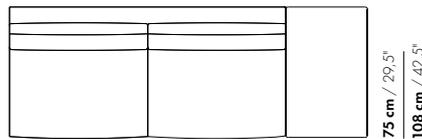

260-D-ZA-TL/TR

328 cm / 129,1"  
260 cm / 102,4" 68 cm / 26,8"

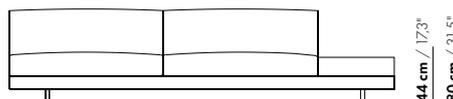

260-D-ZA-TL/TR

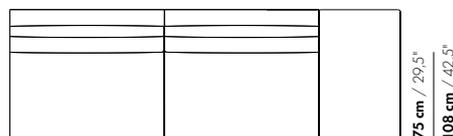

# AXEL XL

Gijs Papavoine 2014

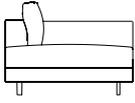

175-D-B-AL-PR/AR-PL

265 cm / 104,3"  
175 cm / 68,9" 72 cm / 28,3"

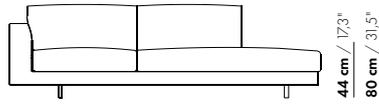

175-D-B-AL-PR/AR-PL

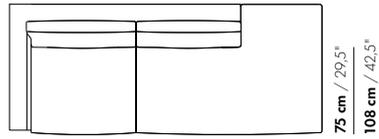

200-D-B-AL-PR/AR-PL

290 cm / 114,2"  
200 cm / 78,7" 72 cm / 28,3"



200-D-B-AL-PR/AR-PL

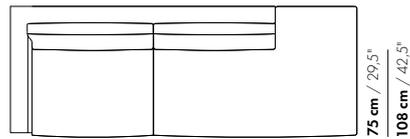

230-D-B-AL-PR/AR-PL

320 cm / 126"  
230 cm / 90,6" 72 cm / 28,3"

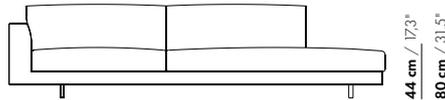

230-D-B-AL-PR/AR-PL

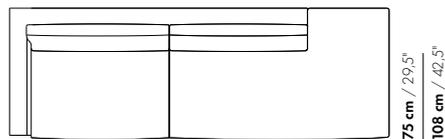

260-D-B-AL-PR/AR-PL

350 cm / 137,8"  
260 cm / 102,4" 72 cm / 28,3"

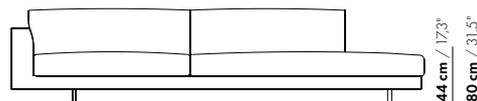

260-D-B-AL-PR/AR-PL

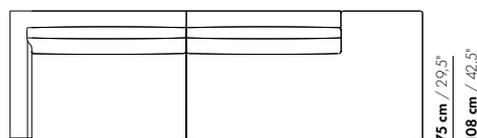

# AXEL XL

Gijs Papavoine 2014

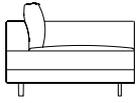

175-D-B-AL-TR/AR-TL

261 cm / 103,2"  
175 cm / 68,9" 68 cm / 26,8"

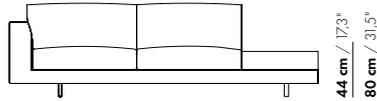

175-D-B-AL-TR/AR-TL

44 cm / 17,3"  
80 cm / 31,5"

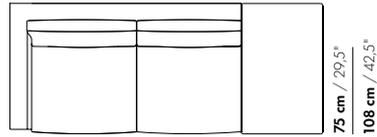

75 cm / 29,5"  
108 cm / 42,5"

200-D-B-AL-TR/AR-TL

286 cm / 112,6"  
200 cm / 78,7" 68 cm / 26,8"

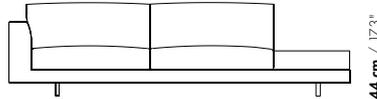

200-D-B-AL-TR/AR-TL

44 cm / 17,3"  
80 cm / 31,5"

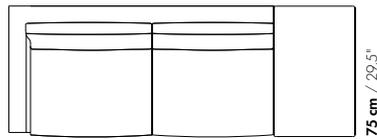

75 cm / 29,5"  
108 cm / 42,5"

230-D-B-AL-TR/AR-TL

316 cm / 124,4"  
230 cm / 90,6" 68 cm / 26,8"

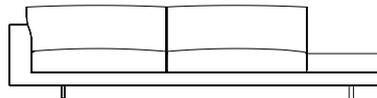

230-D-B-AL-TR/AR-TL

44 cm / 17,3"  
80 cm / 31,5"

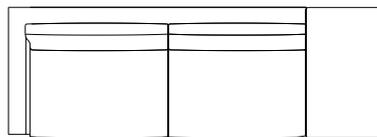

75 cm / 29,5"  
108 cm / 42,5"

260-D-B-AL-TR/AR-TL

346 cm / 136,2"  
260 cm / 102,4" 68 cm / 26,8"

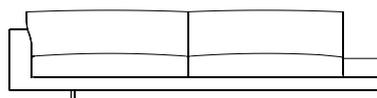

260-D-B-AL-TR/AR-TL

44 cm / 17,3"  
80 cm / 31,5"

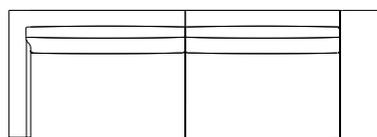

75 cm / 29,5"  
108 cm / 42,5"

# AXEL XL

Gijs Papavoine 2014



5HR-230-ZA  
5HL-230-ZA

230 cm / 90,6"  
175 cm / 68,9"

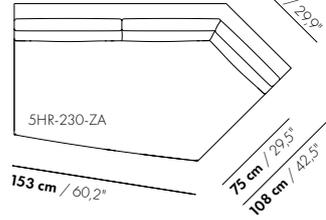

130 cm / 51,2"  
108 cm / 42,5"  
75 cm / 29,5"

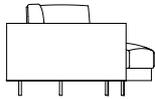
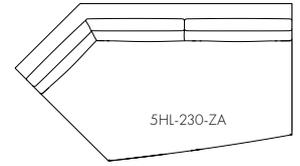

5HR-230-AL  
5HL-230-AR

238 cm / 93,7"  
175 cm / 68,9"

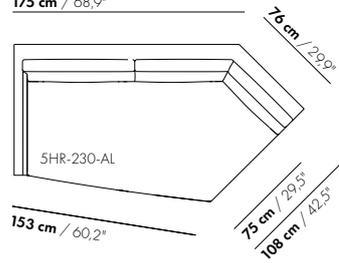

130 cm / 51,2"  
108 cm / 42,5"  
75 cm / 29,5"

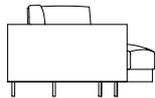
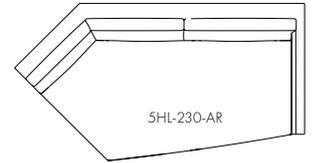

5HR-230-B-AL  
5HL-230-B-AR

246 cm / 96,9"  
175 cm / 68,9"

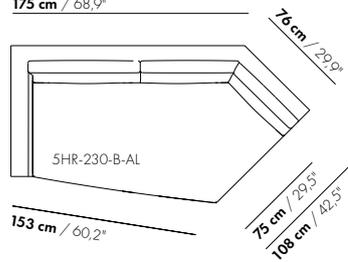

130 cm / 51,2"  
108 cm / 42,5"  
75 cm / 29,5"

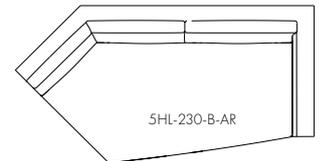



# AXEL XL

Gijs Papavoine 2014



P-108x72

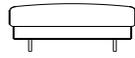

P-108x78

44 cm / 17,3"

72 cm / 28,3"

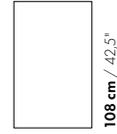

108 cm / 42,5"



P-108x108



P-108x108

44 cm / 17,3"

108 cm / 42,5"

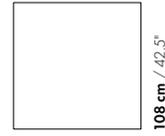

108 cm / 42,5"



T-106x68

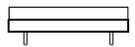

T-106x68

36 cm / 14,3"

68 cm / 26,8"



106 cm / 41,7"

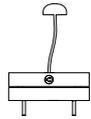

T-106x68

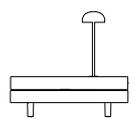

T-106x68

36 cm / 14,3"

68 cm / 26,8"

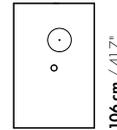

106 cm / 41,7"

Electrification  
USB-charger  
IQ-charger  
lighting

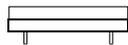

S-T-106x93

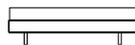

S-T-106x93

36 cm / 14,3"

106 cm / 41,7"



93 cm / 36,6"

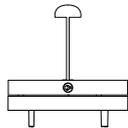

S-T-106x93



S-T-106x93

36 cm / 14,3"

106 cm / 41,7"

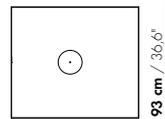

93 cm / 36,6"

Electrification  
USB-charger  
lighting

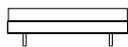

T-106x106

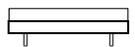

T-106x106

36 cm / 14,3"

106 cm / 41,7"



106 cm / 41,7"

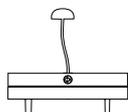

T-106x106

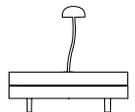

T-106x106

36 cm / 14,3"

106 cm / 41,7"

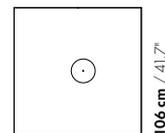

106 cm / 41,7"

Electrification  
USB-charger  
lighting

# AXEL XL

Gijs Papavoine 2014



BACK TABLE

27 cm / 10,7"  
22 cm / 8,7"



70 cm / 27,6"

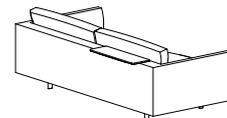

80 cm / 31,5"



60 cm / 23,6"



60 cm / 23,6"



AXEL-XL-H

81 cm / 31,9"



AXEL-XL-S-H

68 cm / 26,8"

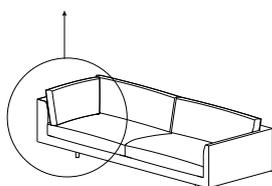

# AXEL XL

Gijs Papavoine 2014

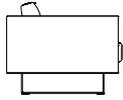

S-175

193 cm / 76"

175 cm / 68,9"

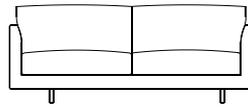

44 cm / 17,3"  
64 cm / 25,2"  
80 cm / 31,5"

S-175

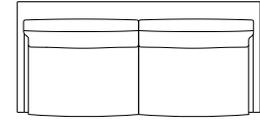

62 cm / 24,4"  
95 cm / 37,4"

S-200

218 cm / 85,8"

200 cm / 78,7"

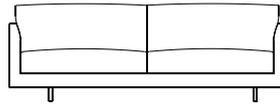

44 cm / 17,3"  
64 cm / 25,2"  
80 cm / 31,5"

S-200

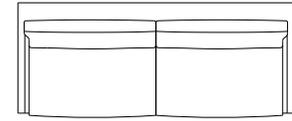

62 cm / 24,4"  
95 cm / 37,4"

S-230

248 cm / 97,6"

230 cm / 90,6"

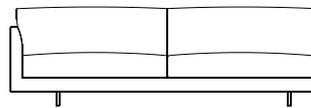

44 cm / 17,3"  
64 cm / 25,2"  
80 cm / 31,5"

S-230

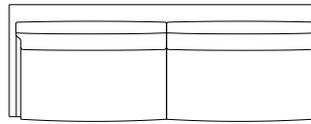

62 cm / 24,4"  
95 cm / 37,4"

S-260

278 cm / 109,4"

260 cm / 102,4"

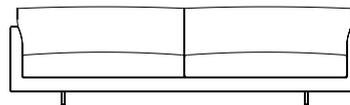

44 cm / 17,3"  
64 cm / 25,2"  
80 cm / 31,5"

S-260

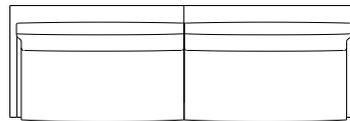

62 cm / 24,4"  
95 cm / 37,4"

# AXEL XL

Gijs Papavoine 2014

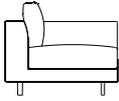

		<p><b>109 cm / 42,9"</b></p> <p><b>100 cm / 39,4"</b></p>	
S-100-AL/AR		<p><b>44 cm / 17,3"</b></p> <p><b>64 cm / 25,2"</b></p> <p><b>80 cm / 31,5"</b></p>	 <p><b>62 cm / 24,4"</b></p> <p><b>95 cm / 37,4"</b></p>
		<p><b>124 cm / 48,8"</b></p> <p><b>115 cm / 45,3"</b></p>	
S-115-AL/AR		<p><b>44 cm / 17,3"</b></p> <p><b>64 cm / 25,2"</b></p> <p><b>80 cm / 31,5"</b></p>	 <p><b>62 cm / 24,4"</b></p> <p><b>95 cm / 37,4"</b></p>
		<p><b>139 cm / 54,7"</b></p> <p><b>130 cm / 51,2"</b></p>	
S-130-AL/AR		<p><b>44 cm / 17,3"</b></p> <p><b>64 cm / 25,2"</b></p> <p><b>80 cm / 31,5"</b></p>	 <p><b>62 cm / 24,4"</b></p> <p><b>95 cm / 37,4"</b></p>
		<p><b>184 cm / 72,4"</b></p> <p><b>175 cm / 68,9"</b></p>	
S-175-AL/AR		<p><b>44 cm / 17,3"</b></p> <p><b>64 cm / 25,2"</b></p> <p><b>80 cm / 31,5"</b></p>	 <p><b>62 cm / 24,4"</b></p> <p><b>95 cm / 37,4"</b></p>
		<p><b>209 cm / 82,3"</b></p> <p><b>200 cm / 78,7"</b></p>	
S-200-AL/AR		<p><b>44 cm / 17,3"</b></p> <p><b>64 cm / 25,2"</b></p> <p><b>80 cm / 31,5"</b></p>	 <p><b>62 cm / 24,4"</b></p> <p><b>95 cm / 37,4"</b></p>
		<p><b>239 cm / 94,1"</b></p> <p><b>230 cm / 90,6"</b></p>	
S-230-AL/AR		<p><b>44 cm / 17,3"</b></p> <p><b>64 cm / 25,2"</b></p> <p><b>80 cm / 31,5"</b></p>	 <p><b>62 cm / 24,4"</b></p> <p><b>95 cm / 37,4"</b></p>
		<p><b>269 cm / 105,9"</b></p> <p><b>260 cm / 102,4"</b></p>	
S-260-AL/AR		<p><b>44 cm / 17,3"</b></p> <p><b>64 cm / 25,2"</b></p> <p><b>80 cm / 31,5"</b></p>	 <p><b>62 cm / 24,4"</b></p> <p><b>95 cm / 37,4"</b></p>
			 <p><b>62 cm / 24,4"</b></p> <p><b>95 cm / 37,4"</b></p>

# AXEL XL

Gijs Papavoine 2014

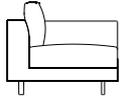

S-100-B-AL/AR

118 cm / 46,5"  
100 cm / 39,4"



S-100-B-AL/AR

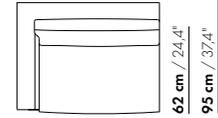

S-115-B-AL/AR

133 cm / 52,4"  
115 cm / 45,3"

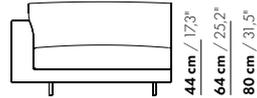

S-115-B-AL/AR

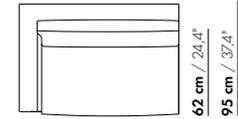

S-130-B-AL/AR

148 cm / 58,3"  
130 cm / 51,2"

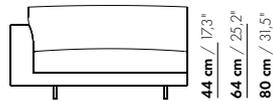

S-130-B-AL/AR

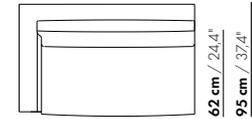

S-175-B-AL/AR

193 cm / 76"  
175 cm / 68,9"

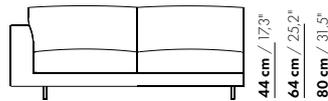

S-175-B-AL/AR

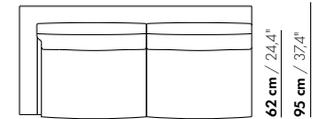

S-200-B-AL/AR

218 cm / 85,8"  
200 cm / 78,7"

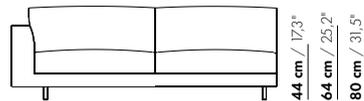

S-200-B-AL/AR

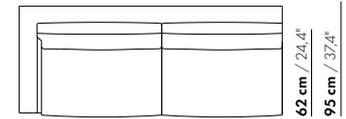

S-230-B-AL/AR

248 cm / 97,6"  
230 cm / 90,6"

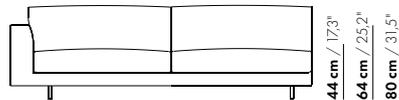

S-230-B-AL/AR



S-260-B-AL/AR

278 cm / 109,4"  
260 cm / 102,4"

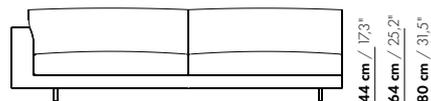

S-260-B-AL/AR

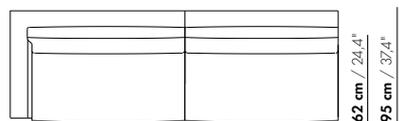

# AXEL XL-S

Gijs Papavoine 2014

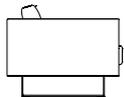

S-175-B

211 cm / 83,1"

175 cm / 68,9"

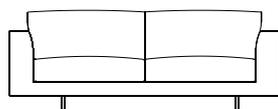

44 cm / 17,3"  
64 cm / 25,2"  
80 cm / 31,5"

S-175-B

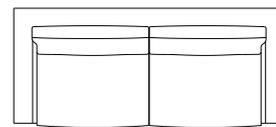

62 cm / 24,4"  
95 cm / 37,4"

S-200-B

236 cm / 92,9"

200 cm / 78,7"

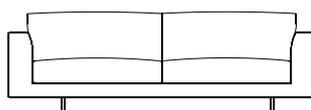

44 cm / 17,3"  
64 cm / 25,2"  
80 cm / 31,5"

S-200-B

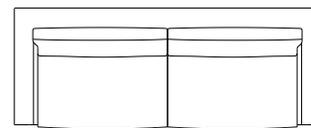

62 cm / 24,4"  
95 cm / 37,4"

S-230-B

266 cm / 104,7"

230 cm / 90,6"

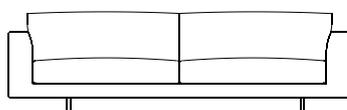

44 cm / 17,3"  
64 cm / 25,2"  
80 cm / 31,5"

S-230-B

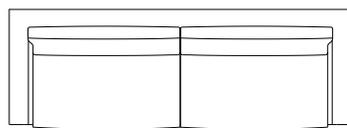

62 cm / 24,4"  
95 cm / 37,4"

S-260-B

296 cm / 116,5"

260 cm / 102,4"

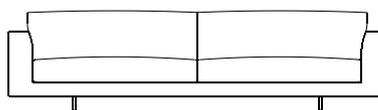

44 cm / 17,3"  
64 cm / 25,2"  
80 cm / 31,5"

S-260-B

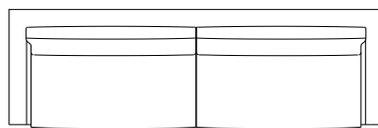

62 cm / 24,4"  
95 cm / 37,4"

# AXEL XL-S

Gijs Papavoine 2014

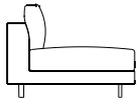

S-100-E

100 cm / 39,4"

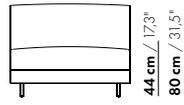

S-100-E

44 cm / 17,3"  
80 cm / 31,5"

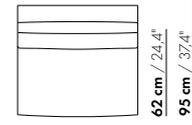

62 cm / 24,4"  
95 cm / 37,4"

S-115-E

115 cm / 45,3"

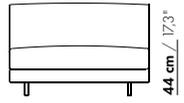

S-115-E

44 cm / 17,3"  
80 cm / 31,5"

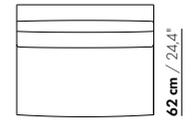

62 cm / 24,4"  
95 cm / 37,4"

S-130-E

130 cm / 51,2"

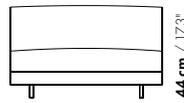

S-130-E

44 cm / 17,3"  
80 cm / 31,5"

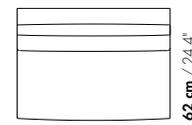

62 cm / 24,4"  
95 cm / 37,4"

S-175-E

175 cm / 68,9"

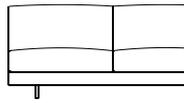

S-175-E

44 cm / 17,3"  
80 cm / 31,5"

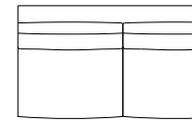

62 cm / 24,4"  
95 cm / 37,4"

S-200-E

200 cm / 78,7"

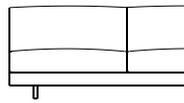

S-200-E

44 cm / 17,3"  
80 cm / 31,5"

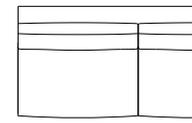

62 cm / 24,4"  
95 cm / 37,4"

S-230-E

230 cm / 90,6"

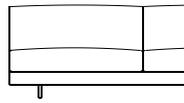

S-230-E

44 cm / 17,3"  
80 cm / 31,5"

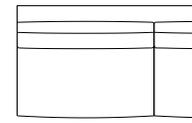

62 cm / 24,4"  
95 cm / 37,4"

S-260-E

260 cm / 102,4"

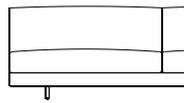

S-260-E

44 cm / 17,3"  
80 cm / 31,5"



62 cm / 24,4"  
95 cm / 37,4"

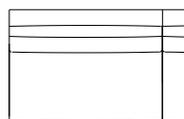

62 cm / 24,4"  
95 cm / 37,4"

# AXEL XL-S

Gijs Papavoine 2014



S-T-93x68

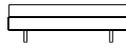

S-T-93x68

36 cm / 14,3"

93 cm / 36,6"



68 cm / 26,8"

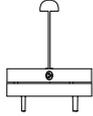

S-T-93x68



S-T-93x68

36 cm / 14,3"

93 cm / 36,6"

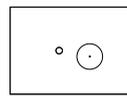

68 cm / 26,8"

Electrification  
USB-charcher  
IQ-charcher  
lighting

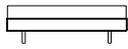

S-T-93x93

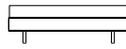

S-T-93x93

36 cm / 14,3"

93 cm / 36,6"



93 cm / 36,6"



S-T-93x93

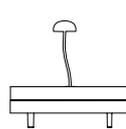

S-T-93x93

36 cm / 14,3"

93 cm / 36,6"

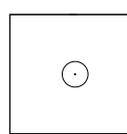

93 cm / 36,6"

Electrification  
USB-charcher  
lighting



S-T-106x93

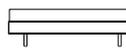

S-T-106x93

36 cm / 14,3"

106 cm / 41,7"

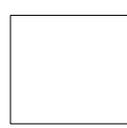

93 cm / 36,6"

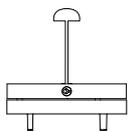

S-T-106x93

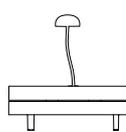

S-T-106x93

36 cm / 14,3"

106 cm / 41,7"

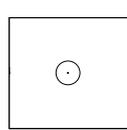

93 cm / 36,6"

Electrification  
USB-charcher  
lighting



# AXEL XL-S

Gijs Papavoine 2014

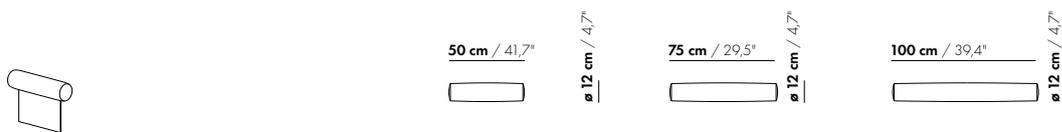
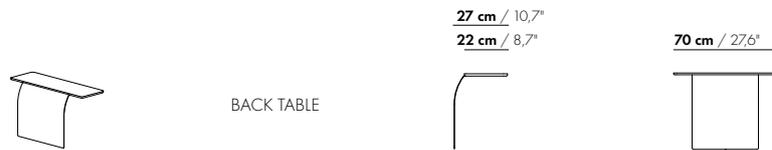
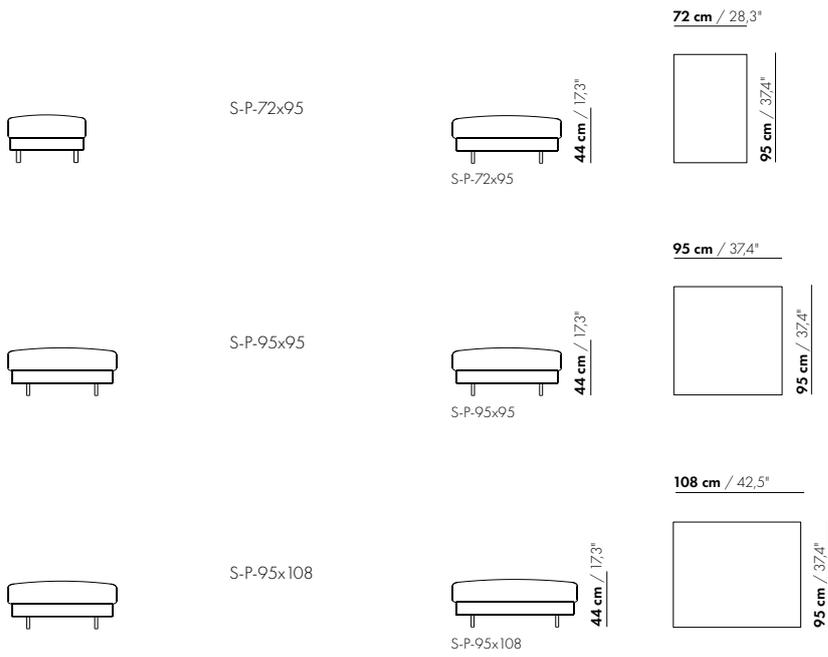

## HOOFDSTEUN

De zijkanten van de hoofdsteun zijn te verstellen. De hoofdsteun is naar voren te verstellen. Axel XL-S hoofdsteun, vooral aanbevolen bij de XL-S variant.

## HEADREST

The sides of the headrest can be adjusted. The headrest can be adjusted forwards. The Axel XL-S headrest is especially recommended for the XL-S version.

## NACKENSTÜTZE

Die Seiten der Nackenstütze können eingestellt werden. Diese können nach vorne verstellt werden. Axel XL-S Nackenstütze, besonders empfohlen für XL-S Variante.

# AXEL XL-S

Gijs Papavoine 2014

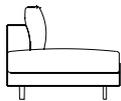

S-175-D-ZA-PL/PR

247 cm / 97,2"

175 cm / 68,9"      72 cm / 28,3"

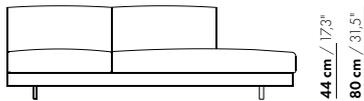

S-175-D-ZA-PL/PR

44 cm / 17,3"  
80 cm / 31,5"

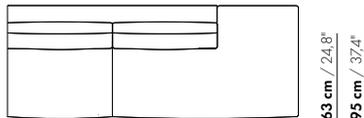

63 cm / 24,8"  
95 cm / 37,4"

S-200-D-ZA-PL/PR

272 cm / 107,1"

200 cm / 78,7"      72 cm / 28,3"

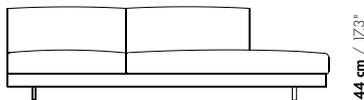

S-200-D-ZA-PL/PR

44 cm / 17,3"  
80 cm / 31,5"

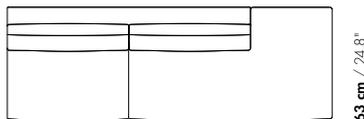

63 cm / 24,8"  
95 cm / 37,4"

S-230-D-ZA-PL/PR

302 cm / 118,9"

230 cm / 90,6"      72 cm / 28,3"

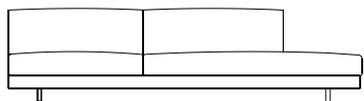

S-230-D-ZA-PL/PR

44 cm / 17,3"  
80 cm / 31,5"

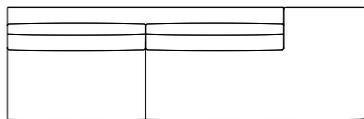

63 cm / 24,8"  
95 cm / 37,4"

S-260-D-ZA-PL/PR

332 cm / 130,7"

260 cm / 102,4"      72 cm / 28,3"

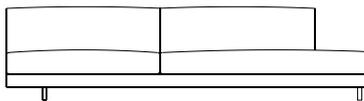

S-260-D-ZA-PL/PR

44 cm / 17,3"  
80 cm / 31,5"

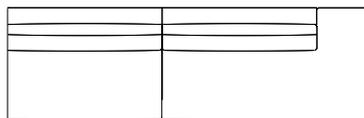

63 cm / 24,8"  
95 cm / 37,4"

# AXEL XL-S

Gijs Papavoine 2014

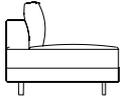

S-175-D-ZA-TL/TR

243 cm / 95,7"

175 cm / 68,9" 68 cm / 26,8"

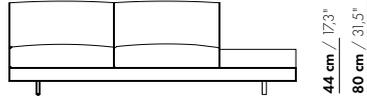

S-175-D-ZA-TL/TR

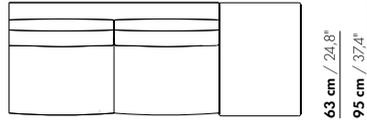

S-200-ZA-D-TL/TR

268 cm / 105,5"

200 cm / 78,7" 68 cm / 26,8"

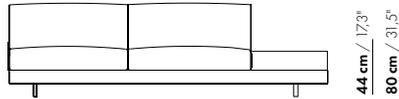

S-200-D-ZA-TL/TR

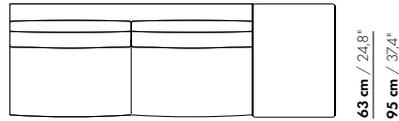

S-230-D-ZA-TL/TR

298 cm / 117,3"

230 cm / 90,6" 68 cm / 26,8"

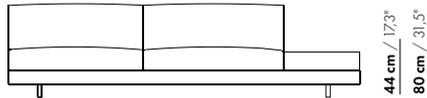

S-230-D-ZA-TL/TR

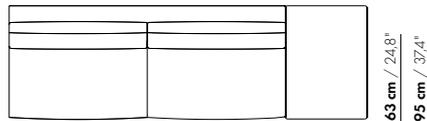

S-260-D-ZA-TL/TR

328 cm / 129,1"

260 cm / 102,4" 68 cm / 26,8"

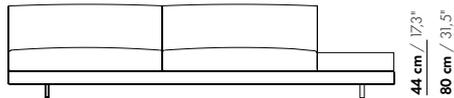

S-260-D-ZA-TL/TR

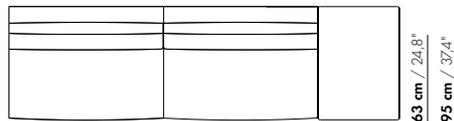

# AXEL XL-S

Gijs Papavoine 2014

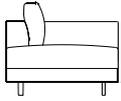

S-175-D-B-AL-PR/AR-PL

265 cm / 104,3"  
175 cm / 68,9" 72 cm / 28,3"

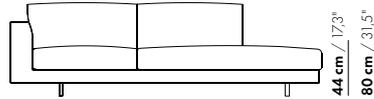

S-175-D-B-AL-PR/AR-PL

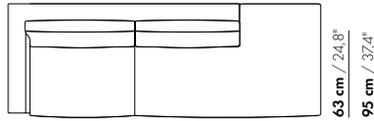

S-200-D-B-AL-PR/AR-PL

290 cm / 114,2"  
200 cm / 78,7" 72 cm / 28,3"

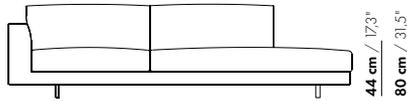

S-200-D-B-AL-PR/AR-PL

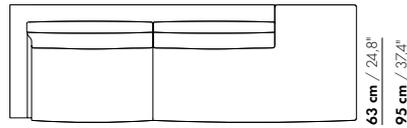

S-230-D-B-AL-PR/AR-PL

320 cm / 126"  
230 cm / 90,6" 72 cm / 28,3"

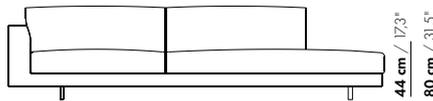

S-230-D-B-AL-PR/AR-PL

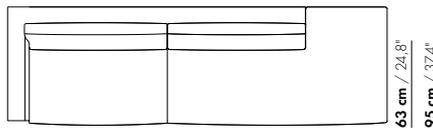

S-260-D-B-AL-PR/AR-PL

350 cm / 137,8"  
260 cm / 102,4" 72 cm / 28,3"

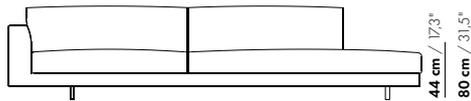

S-260-D-B-AL-PR/AR-PL

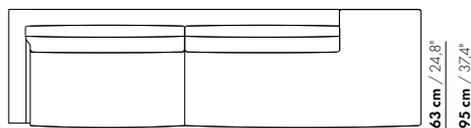

# AXEL XL-S

Gijs Papavoine 2014

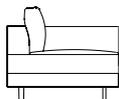

S-175-D-B-AL-TR/AR-TL

261 cm / 102,8"  
175 cm / 68,9" 68 cm / 26,8"

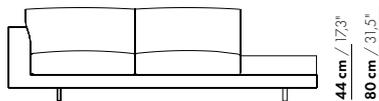

S-175-D-B-AL-TR/AR-TL

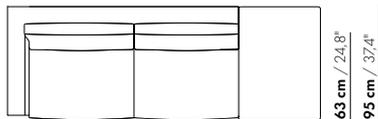

S-200-D-B-AL-TR/AR-TL

286 cm / 112,6"  
200 cm / 78,7" 68 cm / 26,8"

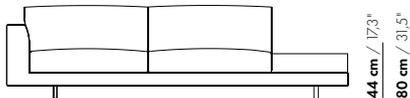

S-200-D-B-AL-TR/AR-TL

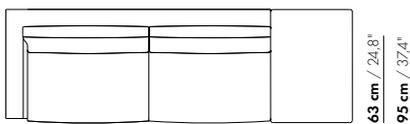

S-230-D-B-AL-TR/AR-TL

316 cm / 124,4"  
230 cm / 90,6" 68 cm / 26,8"

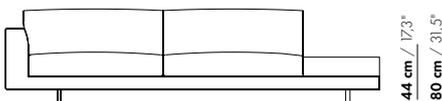

S-230-D-B-AL-TR/AR-TL

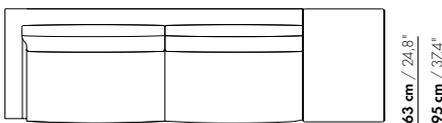

S-260-D-B-AL-TR/AR-TL

346 cm / 136,2"  
260 cm / 102,4" 68 cm / 26,8"

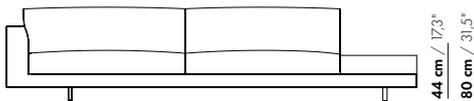

S-260-D-B-AL-TR/AR-TL

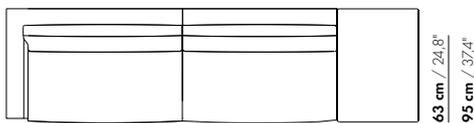

# AXEL XL-S

Gijs Papavoine 2014

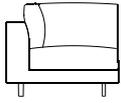

S-H-93x93

93 cm / 36,6"  
63 cm / 24,8"



S-H-93x93

44 cm / 17,3"  
64 cm / 25,2"  
80 cm / 31,5"

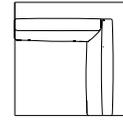

63 cm / 24,8"  
93 cm / 36,6"



S-H-106x96

106 cm / 41,7"  
75 cm / 29,5"

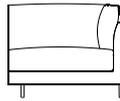

S-H-106x93

44 cm / 17,3"  
64 cm / 25,2"  
80 cm / 31,5"

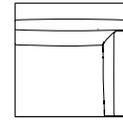

63 cm / 24,8"  
93 cm / 36,6"

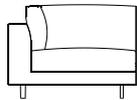

S-H-93x106

93 cm / 36,6"  
63 cm / 24,8"



S-H-93x106

44 cm / 17,3"  
64 cm / 25,2"  
80 cm / 31,5"

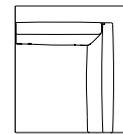

75 cm / 29,5"  
106 cm / 41,7"

# AXEL XL-S

Gijs Papavoine 2014

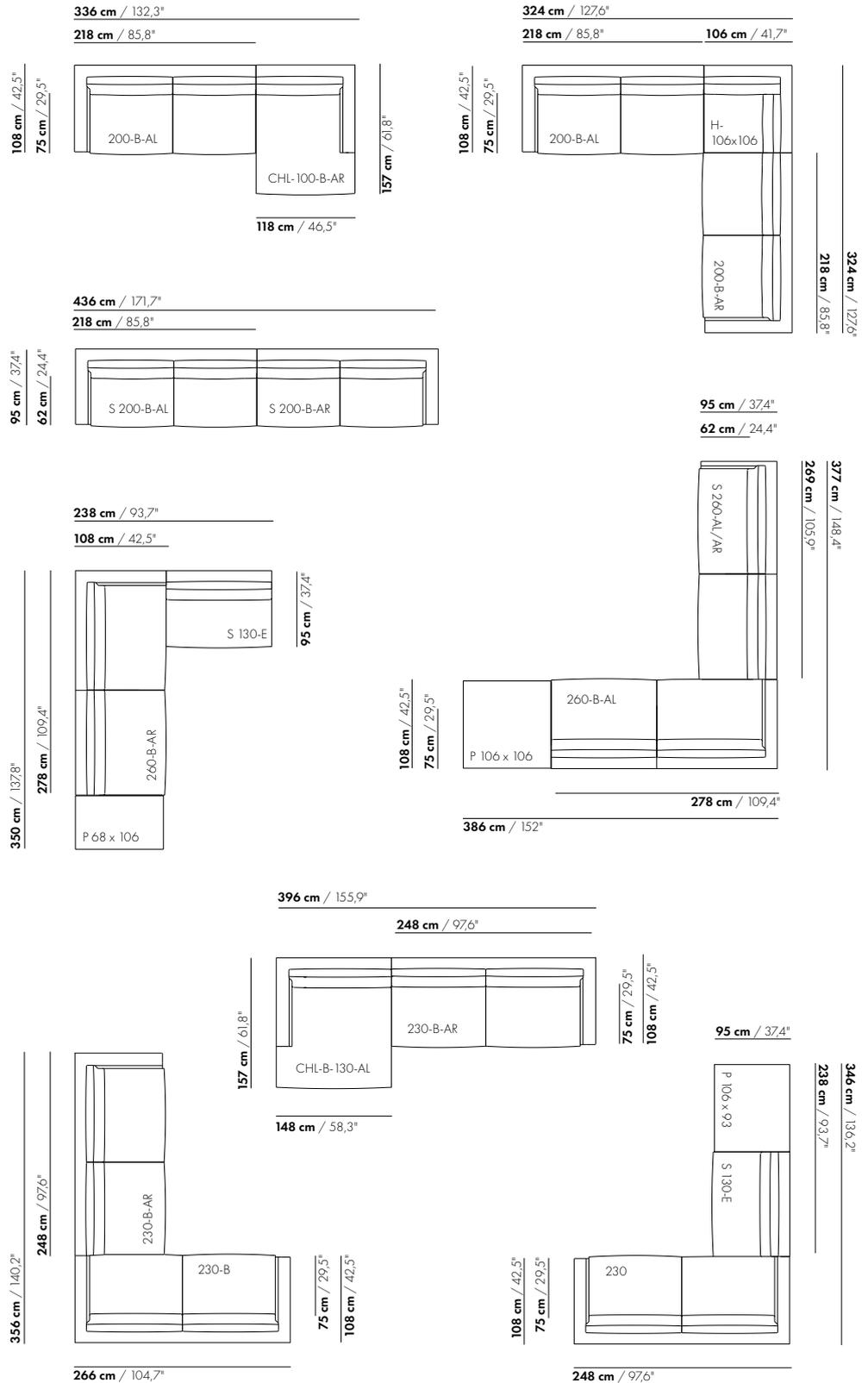

# AXEL XL-S

Gijs Papavoine 2014

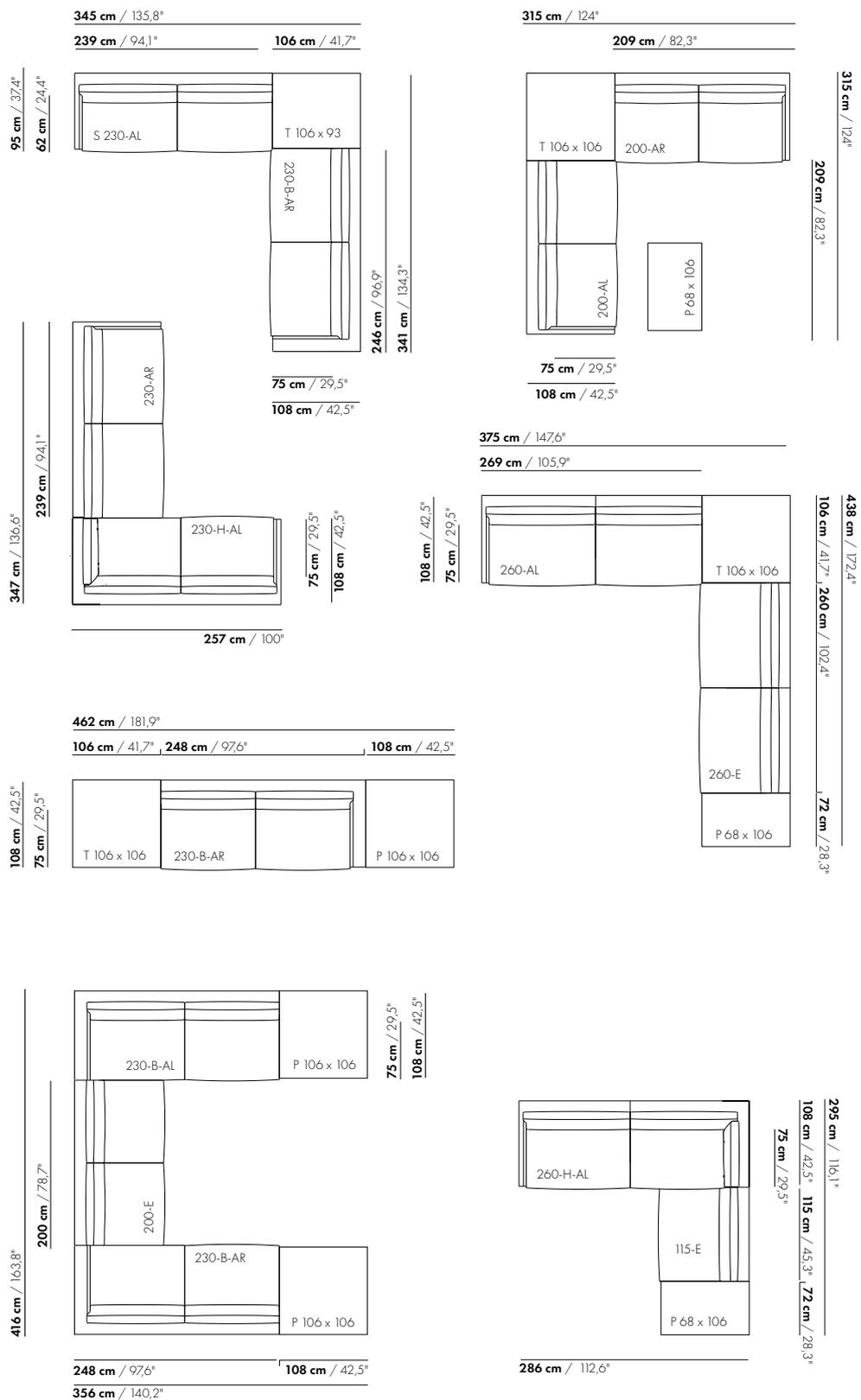



# AXEL XL-S

Gijs Papavoine 2014

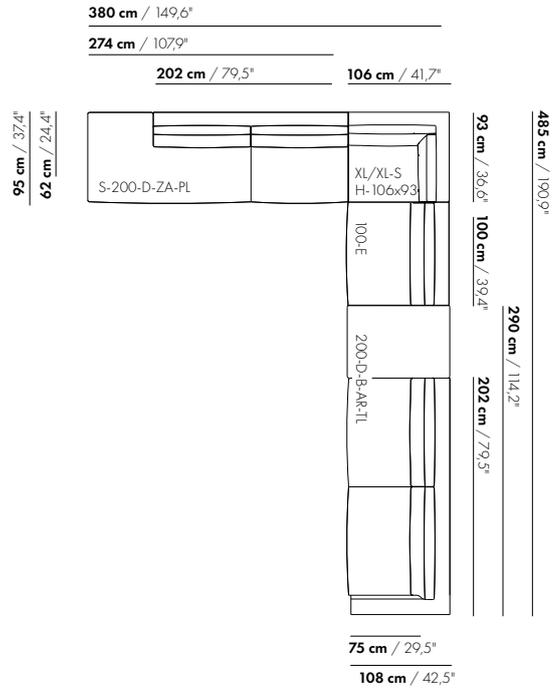
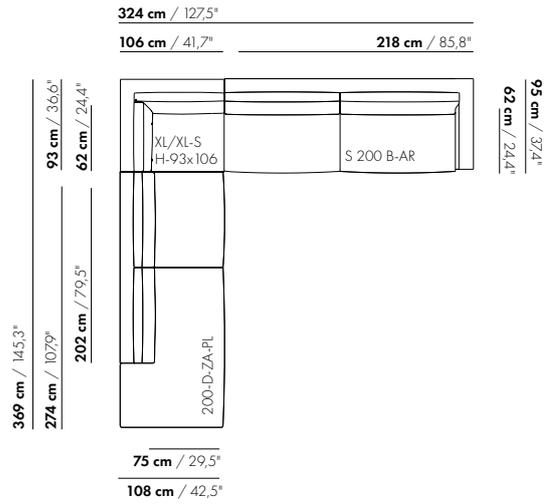

# AXEL XL-S

Gijs Papavoine 2014

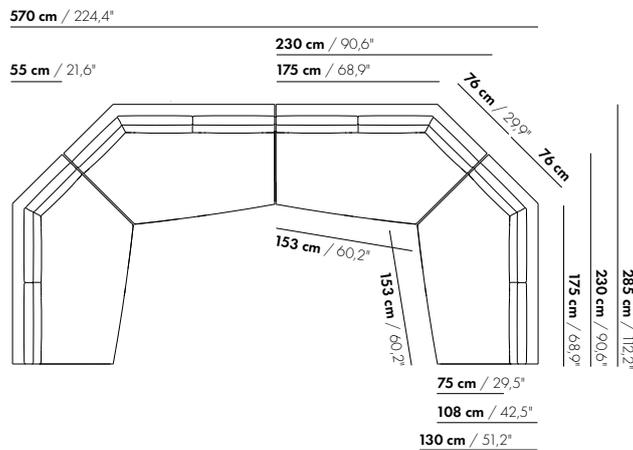
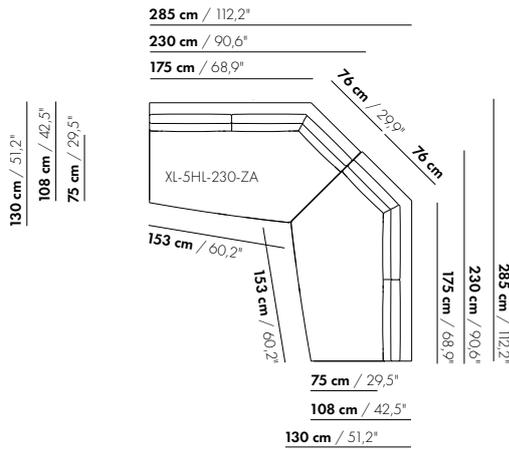
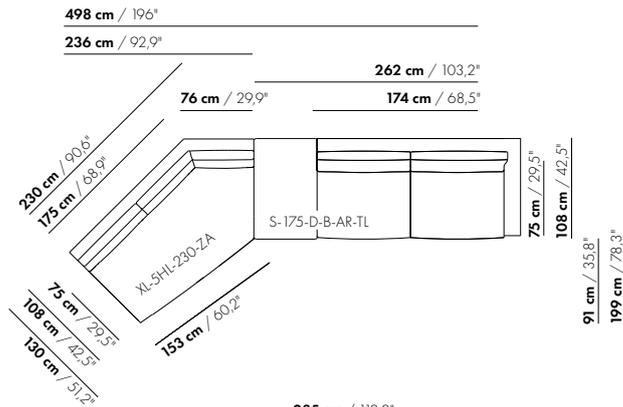
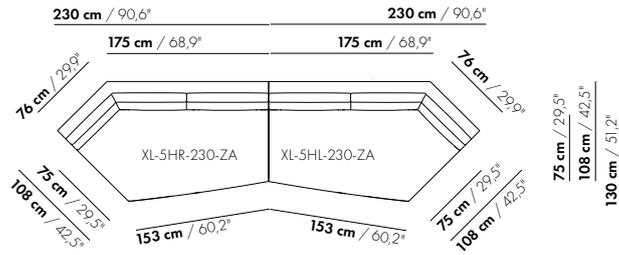

## stof- en leercollectie

MONTIS COLLECTIE	PRIJSKLASSE	SAMENSTELLING	LICHTECHTHEID	MARTINDALE
ALDO	S20	30% viscose, 25% katoen, 20% wol, 20% polyetheen, 20% polyacryl	5-7	50.000
ALLEGRA	S20	40% katoen, 22% polyacryl, 16% viscose, 11% wol, 11% polyamide	4-5	30.000
AMARO	S20	34% viscose, 33% polyacryl, 17% wol, 8% polyester, 4% linnen, 4% cotton	4-5	50.000
BRISTI	S20	63% acryl, 20% polyester, 17% katoen	5	40.000
BRYNA	S20	70% polyacryl, 18% polyetheen, 10% katoen, 2% ander vezels	4-5	40.000
BURANO	S30	100% Trevira CS	>5	150.000
ESOPO	S10	33% polyacryl, 25% viscose, 17% wol, 14% polyetheen, 11% katoen	4-5	30.000
FERRARA	S20	47% polyacryl, 19% wol, 16% polyacryl, 15% katoen, 3% nylon	4-5	30.000
FIDAL	S20	40% wol, 25% viscose, 25% katoen, 5% polyamide, 5% polyester	5-6	40.000
KARO	S20	53% polyacryl, 24% katoen, 10% linnen, 7% polyetheen, 6% viscose	4-5	28.000
LOCARNO	S20	58% viscose, 26% polyacryl, 7% linnen, 7% polyester, 2% zijde	4-5	30.000
MELLOW	S10	50% acryl, 23% katoen, 9% linnen, 9% polyester, 9% viscose	4-5	30.000
MILLER	S30	53% polyacryl, 27% viscose, 20% katoen	5	20.000
MORENA	S20	50% polyacryl, 20% linnen, 19% katoen, 8% nylon	4-5	40.000
NATURE	S20	70% wol, 25% katoen, 5% polyester	5-6	100.000
ORSETTO	S20	34% viscose, 33% polyacryl, 17% wol, 8% polyetheen, 4% linnen, 4% katoen	5	80.000
SIAM	S30	50% viscose, 26% linnen, 23% katoen, 1% polyamide	5	60.000
STRADA	S20	92% katoen BCI, 8% gerecycled katoen	5	50.000
TIKO	S30	36% viscose, 25% linnen, 19% katoen, 18% polyacryl, 2% polyamide	5-6	30.000
VITA	S30	55% viscose, 29% katoen, 16% linnen	5	30.000

MONTIS COLLECTIE LEER	PRIJSKLASSE	SOORT LEDER	LICHTECHTHEID	DIKTE
COUNTRY	L50	Aniline leder	3	1.4-1.6 mm
CUBA	L30	Aniline leder	3	1.0-1.2 mm
DORO	L40	Aniline leder	3	2.0-2.2 mm
MYRA	L20	Semi-aniline leder	4-5	1.0-1.2 mm
NABUK	L40	Aniline leder	3	1.3-1.5 mm
NOVARA	L30	Aniline leder, licht gepolijst	3	2.0-2.2 mm
RANCHO	L40	Aniline leder	3	1.4-1.6 mm
TOBAGO	L20	Aniline afgewerkt leder	3	1.2-1.4 mm
TRINIDAD	L50	Aniline leder	3	2.0-2.2 mm

LEER COLLECTIE DERDEN	PRIJSKLASSE	SOORT LEDER	LICHTECHTHEID	DIKTE
BOX LAND	L20	Geprent gepigmenteerd	>5	1.4-1.6 mm
ELMOFOT	L40	Semi-aniline leder	6	1.0-1.3 mm
PANAMA	L20	Geprent gepigmenteerd	6	1.0-1.2 mm

DE PLOEG	PRIJSKLASSE	SAMENSTELLING	LICHTECHTHEID	MARTINDALE
ALMA	S10	100% polyester	6	70.000
ALTO	S30	36% scheerwol, 22% polyetheen, 7% katoen,	7	80.000
BIRK	S30	30% polyethyleen, 20% katoen, 20% viscose, 15% polyacryl, 15% linnen	5-6	20.000
BOLD	S50	70% scheerwol, 25% polyester, 5% pa front, 100% pes backing	5	20.000
KREDA	S30	35% polyacryl, 23% viscose, 20% polyester, 11% katoen, 11% linnen	5-6	100.000
MONZA	S30	12% polyester, 16% wol, 20% rayon, 24% katoen, 28% acryl	5-7	80.000
MONZA MELANGE	S30	12% polyester, 16% wol, 20% rayon, 24% katoen, 28% acryl	5-7	80.000
MOSS	S20	10% katoen, 15% polyetheen, 30% viscose, 40% acryl, 5% zijde	5	60.000
NUBIS	S30	45% polyester, 40% polyacryl, 11% katoen, 2% polyamide, 2% wol	7	100.000
OLIVE	S20	100% polyester	6	100.000
PANAMA	S40	100% scheerwol	5-6	60.000
PANAMA PLUS	S40	10% katoen, 10% polyester, 80% scheerwol	5-6	90.000
PLOEGWOOL	S40	100% scheerwol	6	90.000
PRAIRIE	S30	40% viscose 30% polyester, 25% katoen, 5% polyamide	5-6	90.000
RENO	S10	15% Katoen, 85% polyester	5-6	45.000
SERRA	S30	15% linnen, 15% katoen, 20% polyester, 5% viscose, 40% polyacryl, 5% polyamide	6-7	70.000

DE PLOEG	PRIJSKLASSE	SAMENSTELLING	LICHTECHTHEID	MARTINDALE
STEPPE	S30	57% scheerwol, 38% polyester, 5% polyamide	5-6	90.000
TWINWOOL	S40	70% scheerwol, 30% bionisch gerecycled	5-6	100.000
UMBRA	S30	51% acryl, 24% viscose, 14% katoen, 8% polyester, 3% andere vezels	6-7	100.000
VIVID	S10	100% polyester	5-6	40.000
KVADRAT	PRIJSKLASSE	SAMENSTELLING	LICHTECHTHEID	MARTINDALE
CANVAS 2	S40	90% scheerwol, 10% nylon	6	100.000
CODA 2	S50 + 5%	90% scheerwol, 10% nylon	6-7	100.000
DIVINA 3	S40	100% scheerwol	7	45.000
DIVINA MD	S40	100% scheerwol	8	45.000
DIVINA MELANGE 3	S40	100% scheerwol	9	45.000
FIORD 2	S40	92% scheerwol, 8% nylon	6	60.000
HALLINGDAL 65	S40	70% scheerwol, 30% viscose	7	100.000
MAPLE	S10	81% viscose, 15% linnen, 4% polyester	5-7	30.000
REMIX 3	S20	90% scheerwol, 10% nylon	5	100.000
RE-WOOL	S30	45% scheerwol, 45% gerecycleerde wol, 10% nylon	7	50.000
SABI	S40	65% scheerwol (kamgaren) 23% gerecycleerde wol 12% nylon	5-7	80.000
SAVANNA	S30	34% polyester 31% scheerwol 26%, acryl 4% katoen, 3% nylon, 2% linnen	6-7	45.000
STEELCUT 2	S40	90% scheerwol, 10% nylon	6-7	80.000
STEELCUT QUARTET	S40	90% scheerwol, 10% nylon	6-7	80.000
STEELCUT TRIO	S40	90% scheerwol, 10% nylon	6-7	100.000
TONICA 2	S40	100% scheerwol	7	45.000
KVADRAT / FEBRIK	PRIJSKLASSE	SAMENSTELLING	LICHTECHTHEID	MARTINDALE
APPAREL	S50	21% wol, 11% polyamide, 7% polyester, 1% elastaan, 60% polyester vulling	6-7	100.000
MIZMAZE	S40	60% polyester, 30% wol 10% nylon	6	100.000
MOSAIC 2	S40	46% polyester vulling, 27% wol, 12% polyester, 9% polyamide, 6% elastane	6-7	100.000
SPRINKLES	S40	40% polyester vulling, 30% wol, 20% polyester, 10% polyamide	7	60.000
KVADRAT / RAF SIMONS	PRIJSKLASSE	SAMENSTELLING	LICHTECHTHEID	MARTINDALE
SUNNIVA 3	S40	58% scheerwol, 25% viscose, 8% linnen, 5% nylon, 4% polyester	5-6	50.000
VANIR	S50 + 5%	90% scheerwol, 8% nylon	6-7	100.000
VIDAR 4	S50 + 5%	94% scheerwol, 6% nylon	5-6	100.000
KVADRAT / SAHCO	PRIJSKLASSE	SAMENSTELLING	LICHTECHTHEID	MARTINDALE
BALBOA	S50	100% polyester FR	5-6	100.000
BARU	S50 + 5%	87% wol, 10% polyester, 3% polyamide	4-5	65.000
FEZ	S50 + 5%	83% katoen, 15% polyester, 2% viscose	5-6	60.000
MOSS	S30	52% katoen, 22% viscose, 14% polyacryl, 6% linnen, 3% polyester, 3% nylon	5-7	50.000
SAFIRE	S30	43% viscose, 17% polyacryl, 15% scheerwol, 9% katoen, 8% polyester/linnen	5-6	44.000
ZERO	S40	65% katoen, 20% polyacryl 15% polyester	5-6	70.000
ROHI	PRIJSKLASSE	SAMENSTELLING	LICHTECHTHEID	MARTINDALE
CLEO	S40	95% scheerwol, 5% polyamide	5-8	70.000
CREDO	S30	95% scheerwol, 5% polyamide	5-8	110.000
MICA	S30	95% scheerwol, 5% polyamide	5-8	70.000
NOVUM	S40	96% scheerwol, 4% polyamide	5-8	90.000
OPERA	S40	96% scheerwol, 4% polyamide	5-8	90.000
SERA	S30	94% scheerwol, 6% polyamide	5-8	122.000
TOPIA	S30	95% scheerwol, 5% polyamide	5-8	50.000
ZIMMER & ROHDE	PRIJSKLASSE	SAMENSTELLING	LICHTECHTHEID	MARTINDALE
INFINITY PLUS VELVET	S40	100% polyester	6	100.000
INFINITY LINEN LOOK	S40	74% acryl, 26% polyester,	6	30.000
INFINITY COTTON FEEL	S40	100% acryl	5	50.000

Indien u kiest voor een materiaal dat niet in ons overzicht vermeld staat, betreft het een ingezonden bekleding.

## stoffen en leer op soort



STOFFEN COLLECTIE MONTIS	PRIJSKLASSE
ALDO	S20
ALLEGRA	S20
AMARO	S20
BRISTI	S20
BRYNA	S20
BURANO	S30
ESOPO	S10
FERRARA	S20
FIDAL	S20
KARO	S20
LOCARNO	S20
MELLOW	S10
MILLER	S30
MORENA	S20
NATURE	S20
ORSETTO	S20
SIAM	S30
STRADA	S20
TIKO	S30
VITA	S30

LEER COLLECTIE MONTIS	PRIJSKLASSE
COUNTRY	L50
CUBA	L30
DORO	L40
MYRA	L20
NABUK	L40
NOVARA	L30
RANCHO	L40
TOBAGO	L20
TRINIDAD	L50

LEER COLLECTIE DERDEN	PRIJSKLASSE
BOX LAND	L20
ELMOSOFT	L40
PANAMA	L20

DE PLOEG	PRIJSKLASSE
ALMA	S10
ALTO	S30
BIRK	S30
BOLD	S50
KREDA	S30
MONZA	S30
MONZA MELANGE	S30
MOSS	S20
NUBIS	S30
OLIVE	S20
PANAMA	S40
PANAMA PLUS	S40
PLOEGWOOL	S40
PRAIRIE	S30
RENO	S10
SERRA	S30
STEPPE	S30
TWINWOOL	S40

DE PLOEG	PRIJSKLASSE
UMBRA	S30
VIVID	S10

KVADRAT	PRIJSKLASSE
CANVAS 2	S40
CODA 2	S50 + 5%
DIVINA 3	S40
DIVINA MD	S40
DIVINA MELANGE 3	S40
FIORD 2	S40
HALLINGDAL 65	S40
MAPLE	S10
REMIX 3	S20
RE-WOOL	S30
SABI	S40
SAVANNA	S30
STEELCUT 2	S40
STEELCUT QUARTET	S40
STEELCUT TRIO	S40
TONICA 2	S40

KVADRAT / FEBRIK	PRIJSKLASSE
APPAREL	S50
MIZMAZE	S40
MOSAIC 2	S40
SPRINKLES	S40

KVADRAT / RAF SIMONS	PRIJSKLASSE
SUNNIVA 3	S40
VANIR	S50 + 5%
VIDAR 4	S50 + 5%

KVADRAT / SAHCO	PRIJSKLASSE
BALBOA	S50
BARU	S50 + 5%
FEZ	S50 + 5%
MOSS	S30
SAFIRE	S30
ZERO	S40

ROHI	PRIJSKLASSE
CLEO	S40
CREDO	S30
MICA	S30
NOVUM	S40
OPERA	S40
SERA	S30
TOPIA	S30

ZIMMER & ROHDE	PRIJSKLASSE
INFINITY PLUS VELVET	S40
INFINITY LINEN LOOK	S40
INFINITY COTTON FEEL	S40

Indien u kiest voor een materiaal dat niet in ons overzicht vermeld staat, betreft het een ingezonden bekleding.